

**ISSUE:** Permit to Demolish and Certificate of Appropriateness  
**APPLICANT:** Charles M. Sypula  
**LOCATION:** 733 South Fairfax Street  
**ZONE:** RM/ Residential Townhouse Zone

---

**STAFF RECOMMENDATION**

Staff recommends approval of a Permit to Demolish the rear shed and approval of a Permit to Demolish and Certificate of Appropriateness for a rear addition that is *either* in keeping with the architectural style of the 1967 Colonial Revival renovation or with the late Victorian appearance. Staff recommends denial of a door hood and that any approval include the following conditions:

1. That the applicant work with staff during the building permit process to ensure the details, such as trim profiles are consistent with the Board's direction;
2. That the applicant work with staff in the field to ensure the rooftop AC unit is located in the least visible location and is painted light grey to match the sky, and;
3. The archaeology conditions below shall appear in the General Notes of all site plans and construction drawings that involve demolition or ground disturbance (including Basement/Foundation Plans, Demolition, Erosion and Sediment Control, Grading, Landscaping, Utilities, and Sheeting and Shoring) so that on-site contractors are aware of the requirements:
  - a. The applicant/developer shall call Alexandria Archaeology immediately (703-746-4399) if any buried structural remains (wall foundations, wells, privies, cisterns, etc.) or concentrations of artifacts are discovered during development. Work must cease in the area of the discovery until a City archaeologist comes to the site and records the finds.
  - b. The applicant/developer shall not allow any metal detection to be conducted on the property, unless authorized by Alexandria Archaeology.

**GENERAL NOTES TO THE APPLICANT**

1. **ISSUANCE OF CERTIFICATES OF APPROPRIATENESS AND PERMITS TO DEMOLISH:** Applicants must obtain a stamped copy of the Certificate of Appropriateness or Permit to Demolish PRIOR to applying for a building permit. Contact BAR Staff, Room 2100, City Hall, 703-746-3833, or [preservation@alexandriava.gov](mailto:preservation@alexandriava.gov) for further information.
2. **APPEAL OF DECISION:** In accordance with the Zoning Ordinance, if the Board of Architectural Review denies or approves an application in whole or in part, the applicant or opponent may appeal the Board's decision to City Council on or before 14 days after the decision of the Board.
3. **COMPLIANCE WITH BAR POLICIES:** All materials must comply with the BAR's adopted policies unless otherwise specifically approved.
4. **BUILDING PERMITS:** Most projects approved by the Board of Architectural Review require the issuance of one or more construction permits by Building and Fire Code Administration (including signs). The applicant is responsible for obtaining all necessary construction permits after receiving Board of Architectural Review approval. Contact Code Administration, Room 4200, City Hall, 703-838-4360 for further information.
5. **EXPIRATION OF APPROVALS NOTE:** In accordance with Sections 10-106(B) and 10-206(B) of the Zoning Ordinance, any official Board of Architectural Review approval will expire 12 months from the date of issuance if the work is not commenced and diligently and substantially pursued by the end of that 12-month period.
6. **HISTORIC PROPERTY TAX CREDITS:** Applicants performing extensive, certified rehabilitations of historic properties may separately be eligible for state and/or federal tax credits. Consult with the Virginia Department of Historic Resources (VDHR) prior to initiating any work to determine whether the proposed project may qualify for such credits.



**BAR2015-00200 & BAR2015-00201**



**Note:** Staff coupled the reports for BAR #2015-000 (Permit to Demolish) and BAR #2015-000 (Certificate of Appropriateness) for clarity and brevity. This item requires a roll call vote.

## **I. ISSUE**

The applicant requests a Permit to Demolish the rear ell of the dwelling and a semi-detached shed at the rear property line in order to construct a two story addition. The new addition would extend the full width of the property and project an additional 6 feet from the west wall of the current ell. The new addition will have a low sloped roof, six-over-six Fibrex windows and doors, and clad with beaded wood clapboard siding to match the existing siding on the front of the house, and PVC trim. The applicant also requests approval of a wood deck with stairs on the rear and a new wood door hood on the front elevation. A new, unscreened HVAC unit is proposed on the roof, as close to the center of the roof as possible. No other exterior repairs are proposed.

## **II. HISTORY**

The subject property was constructed as one in a group of four townhomes that were built by J.F. Pettey in **1912**, likely replacing an earlier structure shown on the Hopkins Atlas in 1877. The footprints of the houses have remained unaltered since 1912, based on Sanborn Map research. The associated semi-detached sheds were also constructed in 1912, according to the original building permit. However the 1921 Sanborn Map shows these sheds as frame, not clad CMU as they are currently built. Therefore, while they retain the same footprint, they were likely rebuilt at a later date.

In **1967**, the Seaport Development Corporation, organized by Marissa Smith, a friend of Polly Hulfish who also undertook “do it yourself urban renewal”, purchased 729, 731, 733, and 735 S Fairfax Street to undertake a “total restoration” as noted on the tax assessor’s documentation from that year and in the BAR minutes of February 8, 1967. It was during this renovation that the current six-over-six windows, beaded siding, doors, shutters, and dentil cornices were installed to give the houses a Federal style appearance, which was (and still is) both popular and identifiable with Alexandria’s history. According to building permits, the roof was replaced in 1991.

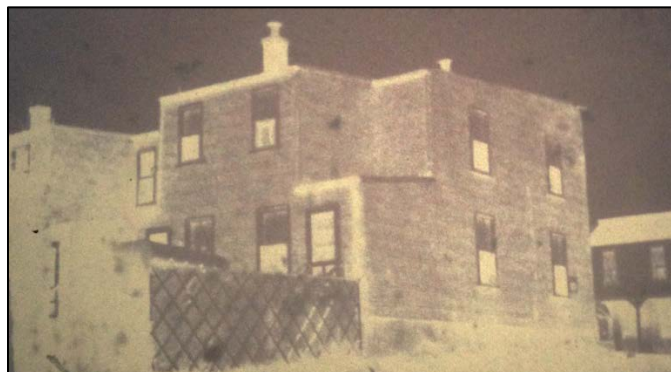

**Figure 1:** Photo in microfiche looking northeast from Jefferson Street, taken prior to the renovation in 1967 and part of the building permit documents shown in Figure 2. The houses appear to have had two-over-two windows on the side and rear elevations.



1967

Form No. 101

TO THE DIRECTOR:

The undersigned applies to the Department of Building and Mechanical Inspections for permit to

REPAIR  ALTER  ENLARGE  The Building described below

Address of Building to be altered: 724 1/2 W. 735.5 Carfax

OWNER'S NAME: [Handwritten Name] OWNER'S TELEPHONE NO.: 599-9067

Building is situated on [Handwritten Address] Street in [Handwritten City] City, Virginia

Building is now occupied as [Handwritten Use]

Any alterations, building will be occupied as [Handwritten Use]

By whom will the work be performed?  OWNER  DAY LABOR  CONTRACTOR

Contractor's Name: [Handwritten Name] Contractor's Address: [Handwritten Address]

Describe the work to be done. If alteration, set out existing conditions to be removed and show proposed new location of doors, windows, etc. and other building construction items to be added and etc.

I hereby acknowledge that I have read this application and certify that the information herein is correct. I also promise that the work proposed under the authority of this permit will be done in accordance with the City Building Code and all applicable ordinances.

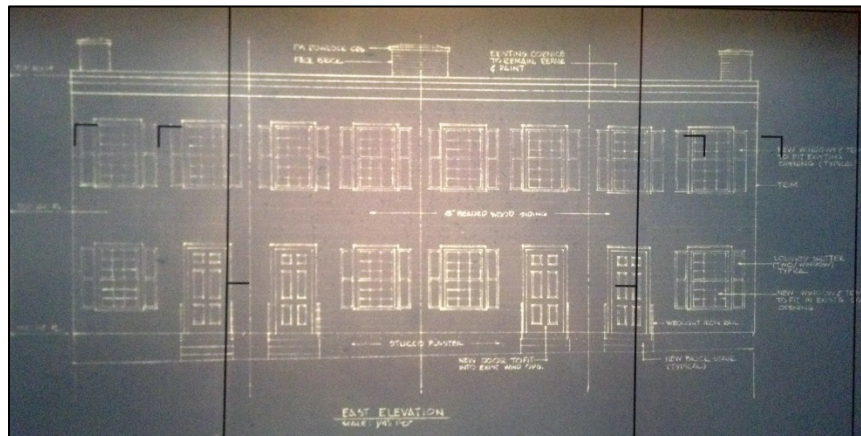
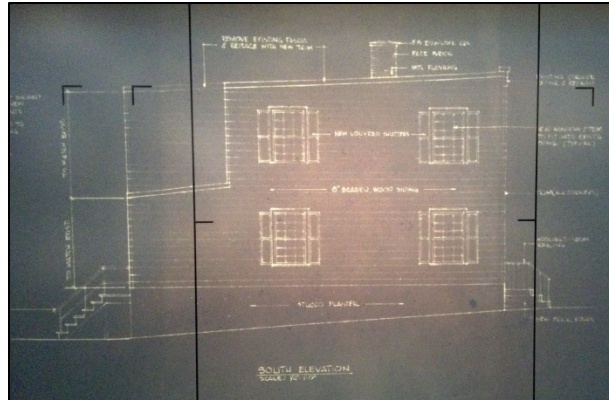

**Figure 2:** The sentiments of the developer are obvious in the description on this building permit #24296 from 1967 that reads: "I plan to take these old things and make beautiful townhomes". The permit regrettably lacks documentation of the houses prior to the renovation other than the photo shown in Figure 1. The elevations show a complete redesign of the exterior, including relocating several doors to former window openings. It is possible the chimney configuration was altered as well.

### III. ANALYSIS

In considering a Permit to Demolish, the Board must consider the following criteria set forth in the Zoning Ordinance, §10-105(B):

- (1) Is the building or structure of such architectural or historical interest that its moving, removing, capsulating or razing would be to the detriment of the public interest?
- (2) Is the building or structure of such interest that it could be made into a historic house?
- (3) Is the building or structure of such old and unusual or uncommon design, texture and material that it could not be reproduced or be reproduced only with great difficulty?
- (4) Would retention of the building or structure help preserve the memorial character of the George Washington Memorial Parkway?

- (5) Would retention of the building or structure help preserve and protect an historic place or area of historic interest in the city?
- (6) Would retention of the building or structure promote the general welfare by maintaining and increasing real estate values, generating business, creating new positions, attracting tourists, students, writers, historians, artists and artisans, attracting new residents, encouraging study and interest in American history, stimulating interest and study in architecture and design, educating citizens in American culture and heritage, and making the city a more attractive and desirable place in which to live?

#### Permit to Demolish for the Shed

While the Board has typically not considered 20<sup>th</sup> century sheds constructed in CMU block to be significant and, in fact, the *Design Guidelines* discourage demolition of 18<sup>th</sup> or 19<sup>th</sup> century structures *only*, staff notes that Board approval of a Permit to Demolish at 733 S Fairfax Street will effectively be setting a precedent for this block and subsequent requests for demolition that will result in the total loss of all four sheds and new additions on the rear are likely. Due to minimum open space requirements in this zone, the construction of the rear addition is contingent on approval of demolition of the shed.

The shed is not of unusual design, material, texture and could easily be reproduced; nor is it of particular historic or public interest given its location and the fact that it has almost certainly been remodeled from its original 1912 construction. Its only potential historic importance is its spatial relationship to the other three sheds and associated houses, as it completes the historic landscape setting of this small rowhouse development. Staff recommends that the Board find none of the above criteria are met, that the proposed demolition meets the *Design Guidelines* and a Permit to Demolish could be granted.

#### Permit to Demolish the Rear Ell

While the Board is sympathetic to the needs of 21<sup>st</sup> century building owners and frequently supports rear additions, the *Design Guidelines* are clear that “the amount of demolition be limited to that necessary to accommodate access to the addition rather than wholesale demolition and replacement of the rear façade”. In addition to the preservation of historic fabric, the visibility and legibility of this block of four townhomes must be considered. In instances where the rear elevations and their relationship to the main block were distinctly legible, the Board has often required that a portion of the historic ell be incorporated into the addition so that the historic massing is still evident from the exterior. The Board most recently required this at 214 S Alfred Street, a late 19<sup>th</sup> century masonry residence, and at 418 S Pitt, a mid-19<sup>th</sup> century frame residence, of which the rear and side elevations were partially visible from a public way. Both of these examples had excellent integrity, as viewed from the exterior, where the relationship between the main block and rear ell was clearly legible.

An important distinction of the subject property is that it was significantly modified in 1967 by a local developer, Seaport Development Corporation. In the same vein as Marianne (Polly) Hulfish’s company, Old Alexandria Restoration Inc., this corporation sought to “restore” houses to an earlier colonial appearance that was favored in Alexandria at that time. These women were arguably responsible for the stabilization of Old Town during a time of Urban Renewal and suburban growth. Their work reflected a national grassroots trend during the mid-twentieth

century towards historic preservation and celebration of our nation's colonial roots, albeit often at the expense of what we would now consider valuable late 19<sup>th</sup> and early 20<sup>th</sup> century architecture.

The applicant is requesting approval to demolish the entire ell and capsulate the rear of the main block of the house. While staff has some concern regarding the loss of what may be the original ell of this one house, it will also undoubtedly serve as precedent for the entire group of four. Nevertheless, staff finds that none of the criteria for a Permit to Demolish are reasonably met: the framing could easily be reproduced, it is unlikely this property could be a historic house given its condition and lack of architectural or historical significance, nor would the removal of the ell be to the detriment of the public or general welfare. Therefore, staff recommends that the Board approve a Permit to Demolish for at least some portion of the rear ell, to be determined by the Board.

#### Certificate of Appropriateness

The *Design Guidelines* encourage designs for residential additions that "...respect the heritage of the historic building to which it is attached as well as adjacent buildings" and these "...should seek to be background statements or echo the design elements of the existing structure." (*Residential Additions* p.5) Staff believes that the scale and mass of the proposed addition, or any addition which projects beyond the rear ell of this group of four townhouses, could have an adverse effect on the immediate block of row homes, as it will change the historic spatial relationship and legibility of the historic house form, particularly as viewed from Jefferson Street. However, the addition will not have a negative impact on the district as a whole and rear additions have routinely been approved by the BAR ever since the district was created.



**Figure 3:** Once the shed is demolished, the rear elevation of the proposed addition will be clearly visible, until and unless a request for a 6 foot fence is made (left image). The proposed addition will extend an additional 6 feet, visible from Jefferson Street (right image).

Beyond the matters of scale and mass, the appropriate style for this addition is difficult to determine because of the complete renovation of these four late Victorian vernacular row-houses in the mid-20<sup>th</sup> century in a Colonial Revival idiom. The intent of the *Design Guidelines* and other BAR policies is that, over time, all maintenance and alterations should strive to restore a building to its period of significance. The period of significance may not be the date of original construction. For instance, many Federal period buildings were later updated with a more stylish Victorian façade in the late 19<sup>th</sup> century. Nationally accepted preservation practice today strongly discourages removal of any now significant Victorian elements to restore an earlier appearance, particularly when the details of that first period are not known from physical or archival evidence.

It is worth considering that when Marissa Smith (with the Board's approval) removed the Victorian elements of the property in 1967, the house was only 55 years old. Clearly the Board and community undervalued the simple late Victorian style at that time. It has now been nearly that long since Smith's work – 48 years. Preservation philosophy in Alexandria has evolved in that time and the Board must now make a finding on the significance of the “do it yourself urban renewal” renovations undertaken by Smith and her contemporaries, who played an integral role in the history of the historic preservation movement in Alexandria.

Arguably, the group of dwellings located at 729-735 South Fairfax Street has two periods of significance: 1912 and 1967. The Board must decide which period of significance - or combination thereof - is to be interpreted through the exterior building fabric to express change over time. Not only will this discussion facilitate the Board's review of the proposed addition and door hood at 733 S. Fairfax Street, but it will inform staff of the Board's preferred preservation philosophy when the owners of the adjacent properties undoubtedly come in for administrative approval of the existing siding or windows, trim, doors, etc. It is quite possible to restore the exterior of the townhome to its Victorian appearance; especially if the beaded siding is removed and historic siding exists underneath with paint ghost marks. This is very common in instances where Masonite, aluminum, or vinyl siding is removed, but only occasionally common where wood siding is removed. However, one example is 1212 Prince Street, where the removal of beaded wood siding exposed historic siding with very clear ghosting of window and door trim and even the molding profiles could be determined.

In this case, the applicant has requested approval of door trim and hood on the front (east) elevation of the subject property to match the neighbor at 725 S Fairfax Street. Staff does not support the door trim or hood for several reasons. First, the proposed door hood would not be keeping with the Federal style of the current façade. It is plausible the house may have had a door hood and perhaps even a transom when originally constructed, but staff has been unable to locate any documentary evidence supporting this claim. The applicant has stated that he is uninterested in doing any exploratory removal of the siding to look for ghosting of trim or a door hood. In staff's experience, examination of the historic siding can provide definitive evidence as to the original appearance of the house. Staff recommends that the Board deny approval of a door hood, but should the owner wish to remove portions of the siding at a later date, staff will work with the applicant to administratively approve trim and a door hood, should the physical evidence indicate one existed.



Regarding the design of the proposed addition, the Board should consider whether an addition at this location should be sympathetic to the 1967 Marissa Smith Colonial Revival style renovation, reflect the Victorian-era construction date, or be decidedly different (ie: modern). Generally the Board has not dictated particular styles for new construction, but has weighed in on the scale, mass, materials, and general aesthetic of the chosen design. The applicant in this case has attempted to match the 1967 re-styling of the house.

Finally, staff notes that the application drawings are somewhat incomplete. Should the Board approve the addition, staff recommends that the Board require the applicant to work with staff to ensure the architectural detailing such as siding, cornices, trim, and windows are consistent with the design direction given by the Board at the hearing and consistent with all BAR policies.

#### **STAFF**

Mary Catherine Collins, Historic Preservation Planner, Planning & Zoning  
Al Cox, FAIA, Historic Preservation Manager, Planning & Zoning

#### **IV. CITY DEPARTMENT COMMENTS**

Legend: C- code requirement R- recommendation S- suggestion F- finding

#### **Zoning Comments**

The subject property is zoned RM, residential and currently an interior townhouse dwelling. The applicant wants to build a rear addition and remove an existing shed to create more open space.

Staff has completed a zoning analysis of the proposed addition and confirmed it complies with the RM zone regulations. The applicant has supplied a certified open space survey confirming compliant open space of 35 percent (340.83 square feet).

- F-1 Applicant must update the FAR/Open Space form section F to match the open space calculation on the plat prior to the BAR hearing.
- F-2 The AC unit cannot be relocated into the area that is required open space.
- C-1 Based on the updated plat with open space documented the proposed addition will comply with zoning. Applicant must update the FAR/Open Space form section F to match the open space calculation on the plat prior to the BAR hearing.

#### **Code Administration**

- F-1 The following comments are for site plan review only. Once the applicant has filed for a building permit and additional information has been provided, code requirements will be based upon the building permit plans and the additional information submitted. If there are any questions, the applicant may contact Charles Cooper, Plan Review Division at Charles.cooper@alexandriava.gov or 703-746-4197.

- C-1 Demolition, building and trades permits are required for this project. Five sets of *construction documents* that fully detail the construction as well as layout and schematics of the mechanical, electrical, and plumbing systems shall accompany the permit application(s) the building official shall be notified in writing by the owner if the registered design professional in the responsible charge is changed or is unable to continue to perform the duties.
- C-2 New construction must comply with the current edition of the Uniform Statewide Building Code (USBC).
- C-3 Adjoining public and private property shall be protected from damage during construction, remodeling and demolition work. Protection shall be provided for footings, foundations, party walls, chimneys, skylights and roofs.
- C-4 The full scope of work shall be identified on the plan prior to the start of construction.
- R-1 Any alterations or revisions to an approved plan shall be reviewed by the plan review staff to determine the applicable regulations.

### **Transportation and Environmental Services**

No comments received

### **Alexandria Archaeology**

- F-1. Historic maps from the mid- to late nineteenth century depict a small structure standing on this lot. The property therefore has the potential to yield archaeological resources which could provide insight into domestic activities in 19<sup>th</sup>-century Alexandria.
- \*R-1. The applicant/developer shall call Alexandria Archaeology immediately (703-838-4399) if any buried structural remains (wall foundations, wells, privies, cisterns, etc.) or concentrations of artifacts are discovered during development. Work must cease in the area of the discovery until a City archaeologist comes to the site and records the finds.
- \*R-2. The applicant/developer shall not allow any metal detection or artifact collection to be conducted on the property, unless authorized by Alexandria Archaeology.
- R-3. The statements in archaeology conditions above marked with an asterisk "\*" shall appear in the General Notes of all site plans and on all site plan sheets that involve demolition or ground disturbance (including Basement/Foundation Plans, Demolition, Erosion and Sediment Control, Grading, Landscaping, Utilities, and Sheeting and Shoring) so that on-site contractors are aware of the requirements.

### **V. ATTACHMENTS**

1 – *Supplemental Materials*

2 – *Application for BAR2015-00200 and 2015-00201:733 S. Fairfax Street*

**From:** [chuck sypula](#)  
**To:** [Mary Catherine Collins](#)  
**Subject:** Modifying My Current Application to the BAR  
**Date:** Tuesday, July 07, 2015 2:33:44 PM  
**Attachments:** [Scan\\_20150707.png](#)

---

Mary Catherine,

Thank you for all the work and research you have done regarding my home project at 733 S Fairfax.

Through this email, I would like to:

- 1)** modify and add to my application to the BAR for changes and alterations to my property at 733 S Fairfax Street by specifically proposing that I be permitted to replace the vinyl shutters with wooden more period authentic shutters on the front of the house;
- 2)** provide you and the BAR with some additional information regarding the proposed changes specifically for the door hood/door trim already requested and;
- 3)** summarize my case for making the changes that are being proposed.

**1) Modification to Current Application**

I would like to request that the following property modification be added to my current application for alterations for 733 S Fairfax.

I would propose the changing out of the current existing vinyl window shutters with new, historically accurate shutters as shown on Attachment A. I would propose that the new shutters would be wooden, be the same size as the shutters currently being replaced and would be painted a rich, deep, semi-gloss black. The new shutters would be affixed to the front of the house with period authentic hardware.

The replacement shutters are being proposed because they would be period authentic and by contrast be much more in keeping with the architecture of the period than the current shutters.

**2) Additional Information**

You will find the additional information promised attached as Attachment B.

**3) Summarization**

If I may, I'd like to summarize my case for my proposed door trim/door hood.

Please understand that you and I and the BAR have the same objective. That objective is to enhance the beauty of both my newly acquired property and neighborhood in which my newly acquired property is located and to do so in a way that maintains the historical integrity of both the property and of that neighborhood.

Having lived in Old Town and just a few hundred feet from this 733 S Fairfax property for nearly 20

years up until 2001, please know that I have great respect for both the history of the area and the work that you and the BAR do to maintain the historical integrity of Old Town.

For that reason alone, I would not even as much as propose anything that might diminish the area's historical value or the BAR's efforts.

While I think it impractical and maybe even impossible to bring this property back to its original state given the sweeping changes made to it in the 1960's, the modifications I am proposing to the front of the house will actually bring the house back more in line with the historical period in which it was built while greatly enhancing the attractiveness of the property and thus the neighborhood.

My proposed changes for the front of the property are for:

- a) the addition of a period authentic door trim/ hood which in turn would allow for;
- b) the removal of the aluminum storm door necessary now to protect the main door from rain and snow run off and;
- c) the replacement of the current vinyl shutters with period authentic wooden shutters.

I am requesting approval for these changes based on the following rationale:

\* In my research done via the Library of Congress website (<http://www.loc.gov/pictures/search/?q=Photograph>) a door hood or front door trim seems to be historically correct and concurrent with the period when apparently your research shows this house was built (1912). Further, there are many such door hoods throughout many Old Town neighborhoods supporting the point that a door hood or door trim is period authentic.

\* In the absence of a modest door trim or a door hood, a storm door is absolutely required to fend off the elements particularly water that inevitably cascades down and across the front of the house and over the front of a totally exposed front door.  
The addition of a period authentic door trim would provide a much needed practical solution to an on going maintenance problem while allowing for the removal of the current aluminum screen door.

\* An aluminum storm door, which again, is necessary if a door hood is not employed, absolutely compromises the historical integrity of the property and is inherently unattractive.

\* The historical nature of the property has already been compromised by the sweeping changes made in the 60's. Getting the house restored to its fully original state at this juncture may, at best, be impractical and, at worst, be impossible. Adding a tastefully done, historically accurate door hood and replacing the current vinyl shutters with historically accurate wooden shutters would actually serve to mitigate the effect of those unfortunate changes made in the 60's and make the property more not less historically accurate than it is currently.

\* A tastefully done, historically accurate door hood or door trim along with the replacement of the current vinyl shutters with wooden shutters, simply put. would enhance the appearance of all the



houses around it and serve to beautify the entire neighborhood.

Thanks again for all your efforts here and now for your for your consideration.

Chuck Sypula



## DEPARTMENT OF PLANNING AND ZONING FLOOR AREA RATIO AND OPEN SPACE CALCULATIONS

### A. Property Information

A1. Street Address 733 S. FAIRFAX ST Zone \_\_\_\_\_  
 A2. 973 x 1.5 = 1459.5  
Total Lot Area Floor Area Ratio Allowed by Zone Maximum Allowable Floor Area

### B. Existing Gross Floor Area

Existing Gross Area*		Allowable Exclusions	
Basement	—	Basement**	—
First Floor	503.84	Stairways**	36
Second Floor	503.84	Mechanical**	13.5
Third Floor	—	Other** SHED DEMOLISH	93.93
Porches/ Other SHED	93.93	Total Exclusions	143.43
<b>Total Gross *</b>	<b>1101.63</b>		

B1. Existing Gross Floor Area \*  
1101.63 Sq. Ft.  
 B2. Allowable Floor Exclusions\*\*  
143.43 Sq. Ft.  
 B3. Existing Floor Area minus Exclusions  
958.2 Sq. Ft.  
 (subtract B2 from B1)

### C. Proposed Gross Floor Area (does not include existing area)

Proposed Gross Area*		Allowable Exclusions	
Basement	—	Basement**	—
First Floor	78.61	Stairways**	—
Second Floor	130.11	Mechanical**	—
Third Floor	—	Other**	—
Porches/ Other	—	Total Exclusions	—
<b>Total Gross *</b>	<b>208.72</b>		

C1. Proposed Gross Floor Area \*  
208.72 Sq. Ft.  
 C2. Allowable Floor Exclusions\*\*  
 \_\_\_\_\_ Sq. Ft.  
 C3. Proposed Floor Area minus Exclusions  
208.72 Sq. Ft.  
 (subtract C2 from C1)

### D. Existing + Proposed Floor Area

D1. Total Floor Area (add B3 and C3) 1166.92 Sq. Ft.  
 D2. Total Floor Area Allowed by Zone (A2) 1459.5 Sq. Ft.

\*Gross floor area is the sum of all gross horizontal areas under roof, measured from the face of exterior walls, including basements, garages, sheds, gazebos, guest buildings and other accessory buildings.

\*\* Refer to the zoning ordinance (Section 2-145(B)) and consult with zoning staff for information regarding allowable exclusions.

If taking exclusions other than basements, floor plans with excluded areas must be submitted for review. Sections may also be required for some exclusions.

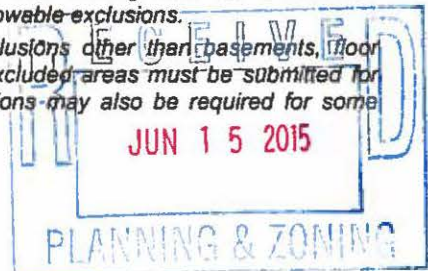

### F. Open Space Calculations

Existing Open Space	295.88
Required Open Space	35% → 340.33
Proposed Open Space	342.29

The undersigned hereby certifies and attests that, to the best of his/her knowledge, the above computations are true and correct.

Signature: \_\_\_\_\_

Date: \_\_\_\_\_

6/15/2015

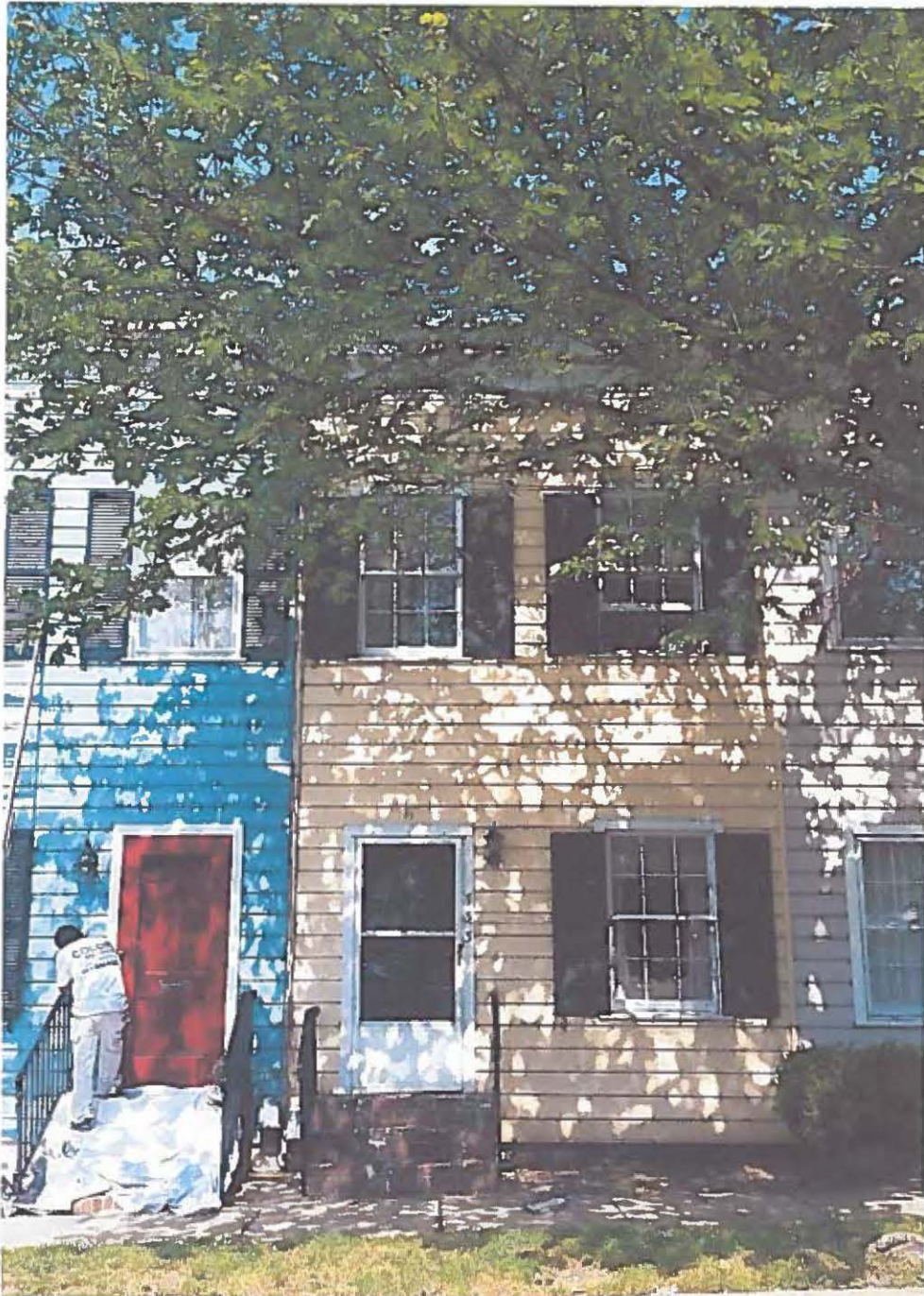

PHOTO #1  
THE FRONT OF 733 FERRY  
S. FAIRFAX ST.

APPLICATION MATERIALS  
BAR2015-00200/00201  
733 S FAIRFAX ST  
6/15/2015





PHOTO # 2  
FROM JEFFERSON ST.  
733 IS THE YELLOW & WHITE HOUSE  
ADJACENT TO THE BLUE HOUSE  
IN FEED GROUND

APPLICATION MATERIALS  
BAR2015-00200/00201  
733 S FAIRFAX ST  
6/15/2015





PHOTO #3  
FROM THE BACK NORTHEAST  
SIDE CORNER SHOWING  
FIRST FLOOR FURTHEST BACK  
WALL, THE FIRST FLOOR SET BACK  
AND THE SECOND STORY

APPLICATION MATERIALS  
BAR2015-00200/00201  
733 S FAIRFAX ST  
6/15/2015

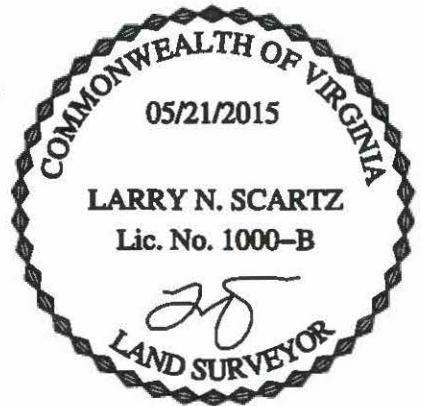
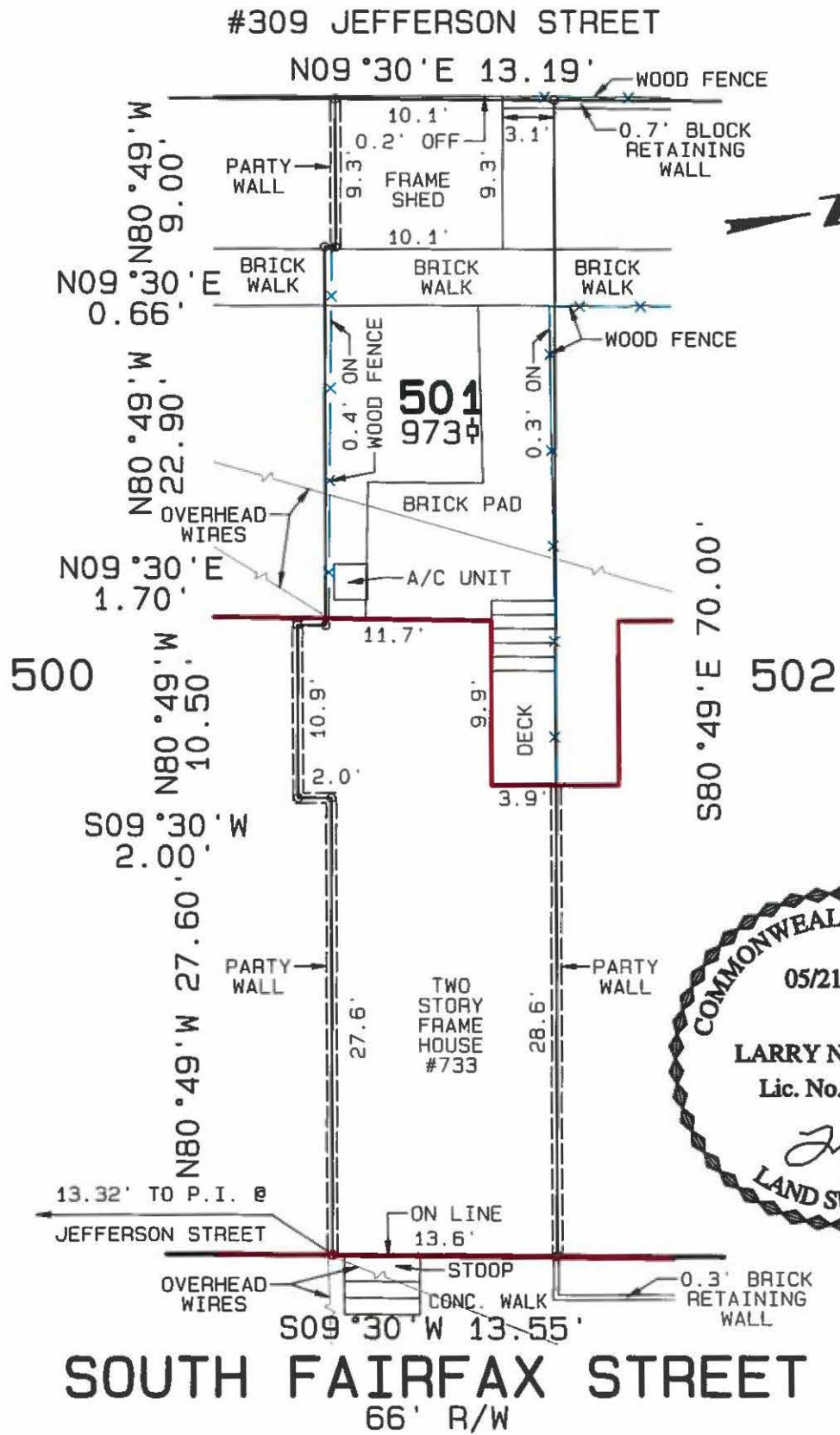

PHYSICAL IMPROVEMENTS SURVEY  
 LOT 501

**DIANNE SUBD.**

CITY OF ALEXANDRIA, VIRGINIA

SCALE: 1"=10' DATE: MAY 21, 2015

CASE NAME: OLER (OTA1505041)  
 TO SYPULA/MCCASKILL

APPLICATION MATERIALS  
 BAR2015-00200/00201  
 733 S FAIRFAX ST  
 6/15/2015

NO TITLE REPORT FURNISHED.

PLAT SUBJECT TO RESTRICTIONS & EASEMENTS OF RECORD OR OTHERWISE.

FENCE LOCATIONS, IF SHOWN, ARE APPROXIMATE ONLY  
 AND DO NOT CERTIFY AS TO OWNERSHIP.

**SCARTZ SURVEYS**

LARRY N. SCARTZ  
 CERTIFIED LAND SURVEYOR  
 WOODBRIDGE, VIRGINIA

LOCAL (703) 494-4181  
 FAX (703) 494-3330  
 LARRY.SCARTZ@SCARTZ.COM





NOTES



DEMO



NEW WORK

A/C MOVES  
TO ROOF

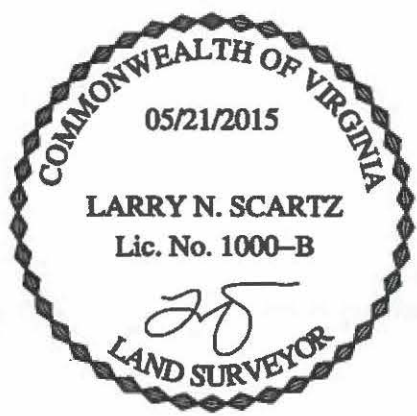
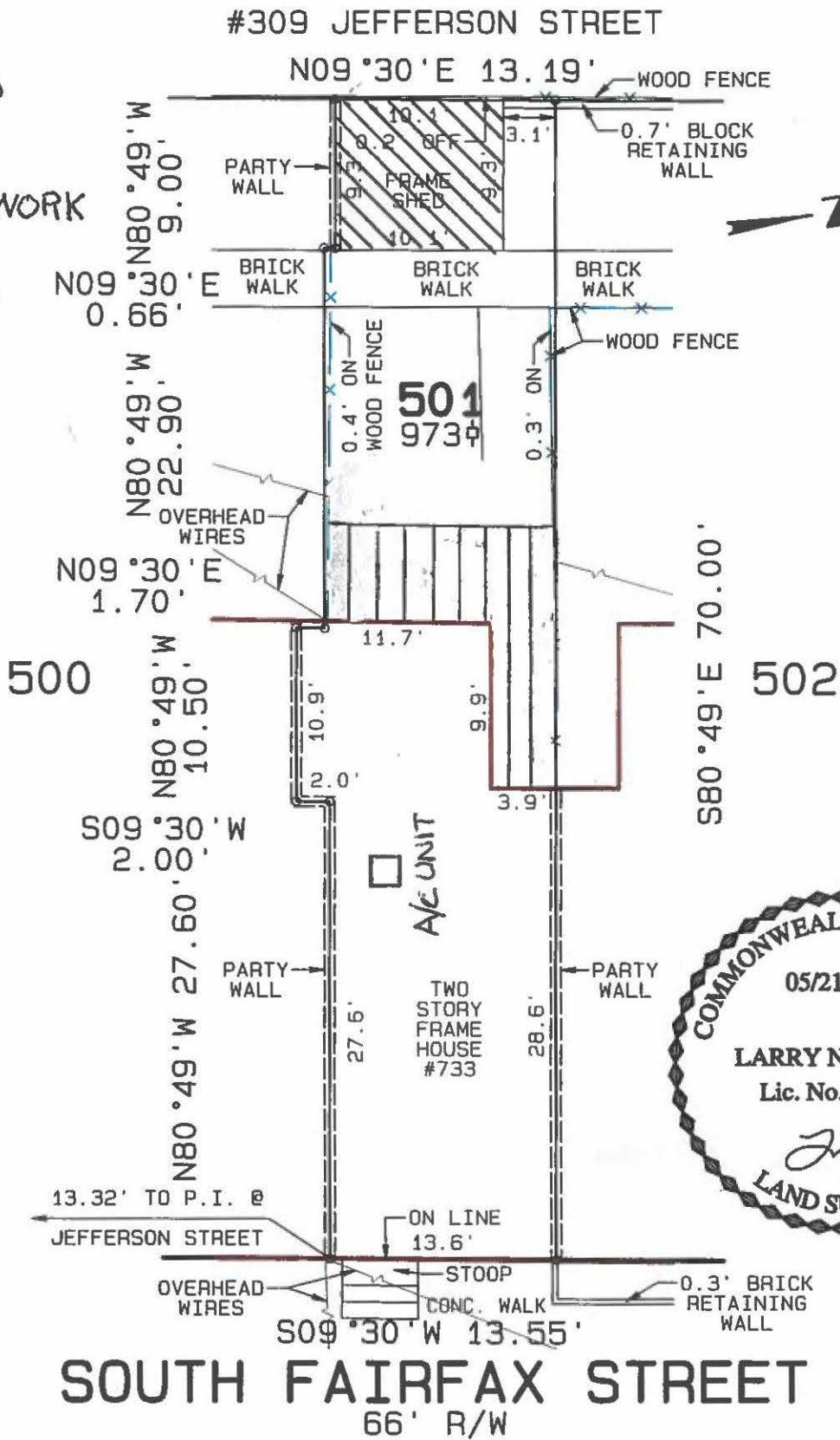

PHYSICAL IMPROVEMENTS SURVEY  
LOT 501  
**DIANNE SUBD.**  
CITY OF ALEXANDRIA, VIRGINIA  
SCALE: 1"=10'      DATE: MAY 21, 2015

CASE NAME: OLER (OTA1505041)  
TO SYPULA/MCCASKILL

NO TITLE REPORT FURNISHED.

PLAT SUBJECT TO RESTRICTIONS & EASEMENTS OF RECORD OR OTHERWISE.

FENCE LOCATIONS, IF SHOWN, ARE APPROXIMATE ONLY  
AND DO NOT CERTIFY AS TO OWNERSHIP.

APPLICATION MATERIALS  
BAR2015-00200/00201  
733 S FAIRFAX ST  
6/15/2015

SCARTZ SURVEYS

LARRY N. SCARTZ  
CERTIFIED LAND SURVEYOR  
WOODBIDGE, VIRGINIA

LOCAL (703) 494-4181  
FAX (703) 494-3330  
LARRY.SCARTZ@SCARTZ.COM



**RECEIVED**  
 JUL -7 2015  
 PLANNING & ZONING

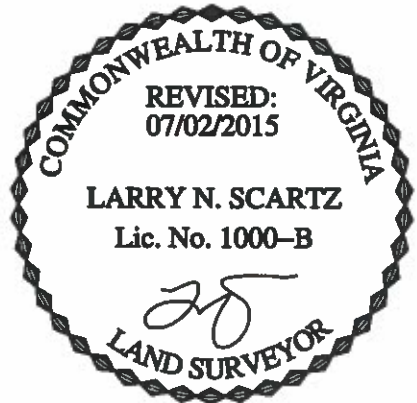
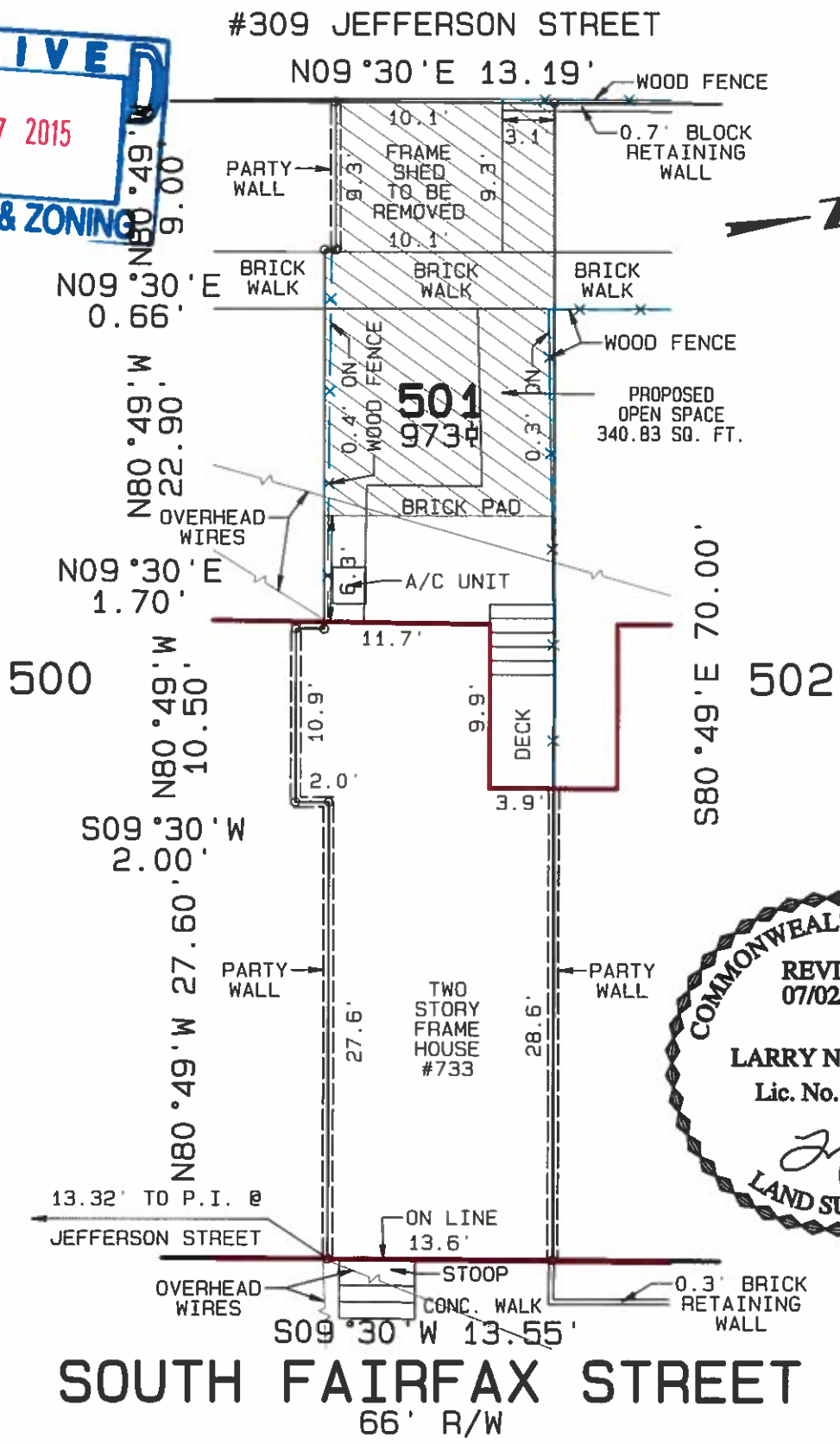

PHYSICAL IMPROVEMENTS SURVEY  
 LOT 501  
**DIANNE SUBD.**  
 CITY OF ALEXANDRIA, VIRGINIA  
 SCALE: 1"=10'      DATE: MAY 21, 2015

<p>CASE NAME: OLER (OTA1505041)              TO SYPULA/MCCASKILL</p> <p><b>MBH</b>  <i>Settlement Group, L.C.</i></p>	<p>NO TITLE REPORT FURNISHED.              PLAT SUBJECT TO RESTRICTIONS &amp; EASEMENTS OF RECORD OR OTHERWISE.              FENCE LOCATIONS, IF SHOWN, ARE APPROXIMATE ONLY AND DO NOT CERTIFY AS TO OWNERSHIP.</p> <p><b>SCARTZ SURVEYS</b></p> <p>LARRY N. SCARTZ      LOCAL (703) 494-4181              CERTIFIED LAND SURVEYOR      FAX (703) 494-3330              WOODBRIDGE, VIRGINIA      LARRY.SCARTZ@SCARTZ.COM</p>
---	--



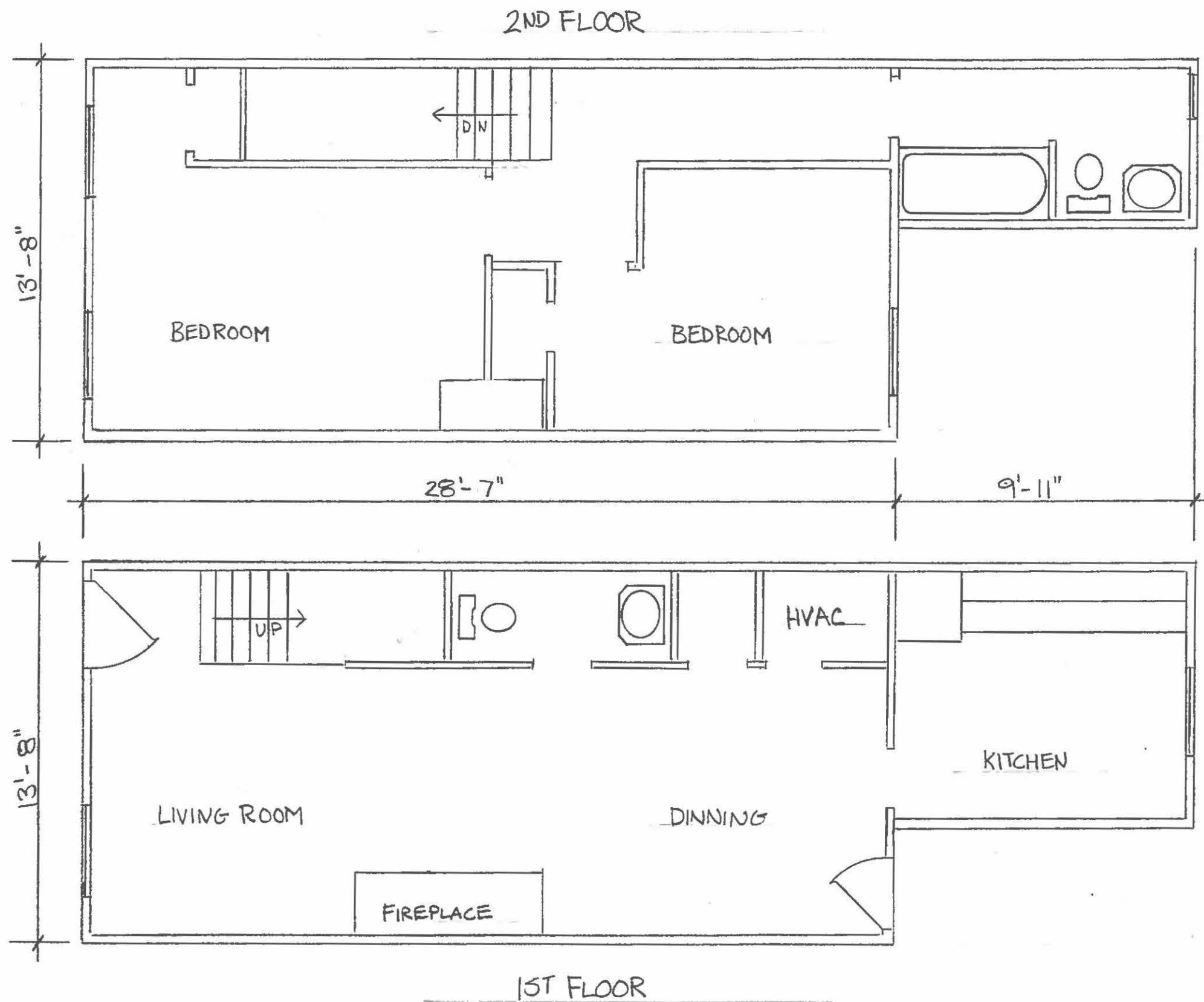

2ND FLOOR SQUARE FOOTAGE  
475.09

1ST FLOOR SQUARE FOOTAGE  
504.79

TOTAL SQUARE FOOTAGE  
979.88

APPLICATION MATERIALS  
BAR2015-00200/00201  
733 S FAIRFAX ST  
6/15/2015

SYPULA RESIDENCE  
733 S, FAIRFAX ST.  
ALEXANDRIA VA.

EXISTING FLOOR PLANS  
1/4" = 1 FOOT

AI

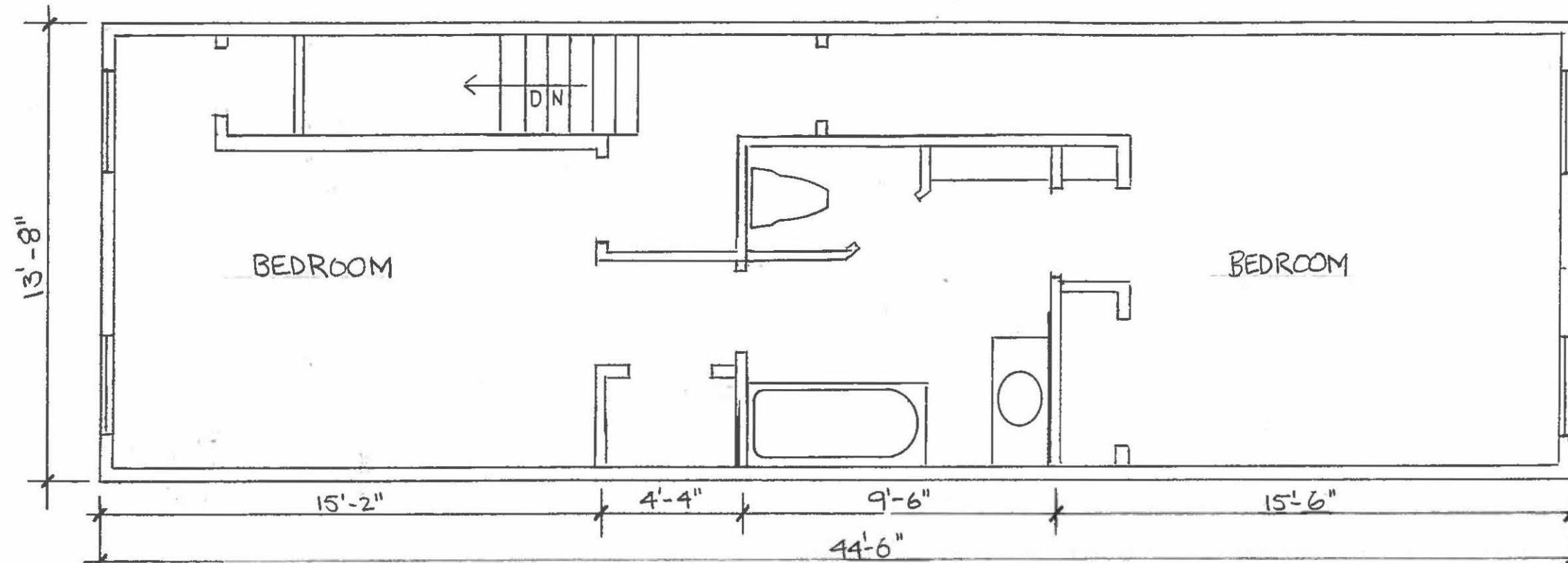

2ND FLOOR SQUARE FOOTAGE  
605.2

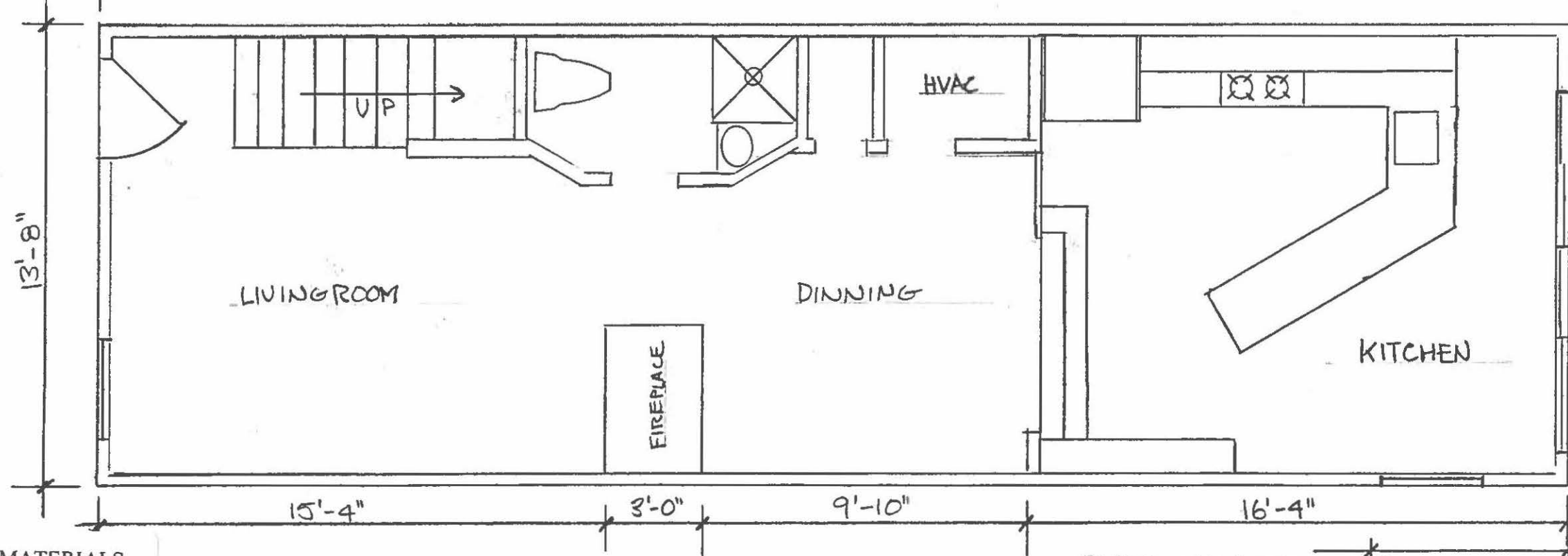

1ST FLOOR SQUARE FOOTAGE  
605.2

TOTAL SQUARE FOOTAGE  
1210.40

WOOD DECK AND  
STEPS

APPLICATION MATERIALS  
BAR2015-00200/00201  
733 S FAIRFAX ST  
6/15/2015

1ST AND 2ND FLOORS  
WITH ADDITION  
1/4" = 1 FOOT A2

NORTH

WEST

SOUTH

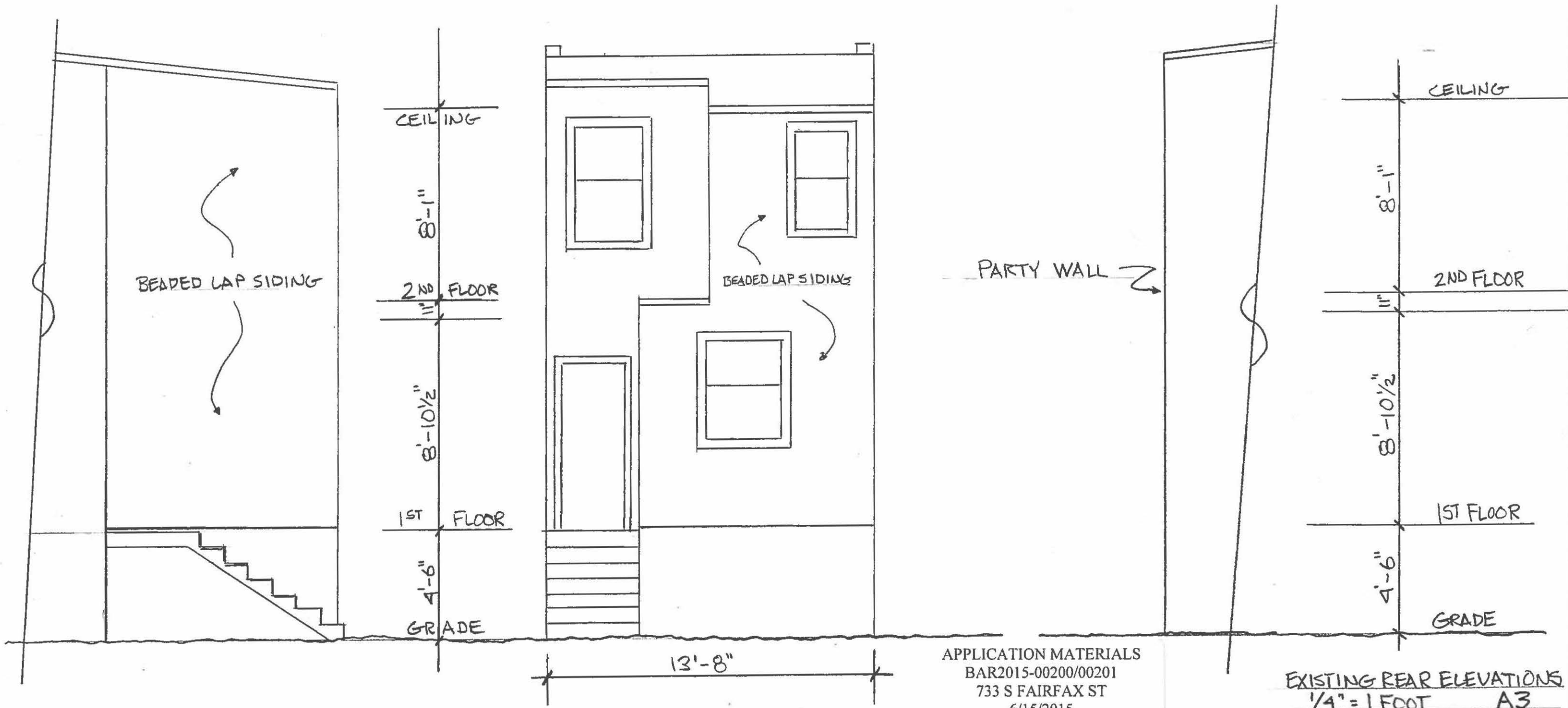

APPLICATION MATERIALS  
 BAR2015-00200/00201  
 733 S FAIRFAX ST  
 6/15/2015

EXISTING REAR ELEVATIONS  
 1/4" = 1 FOOT A3

NORTH

WEST

SOUTH

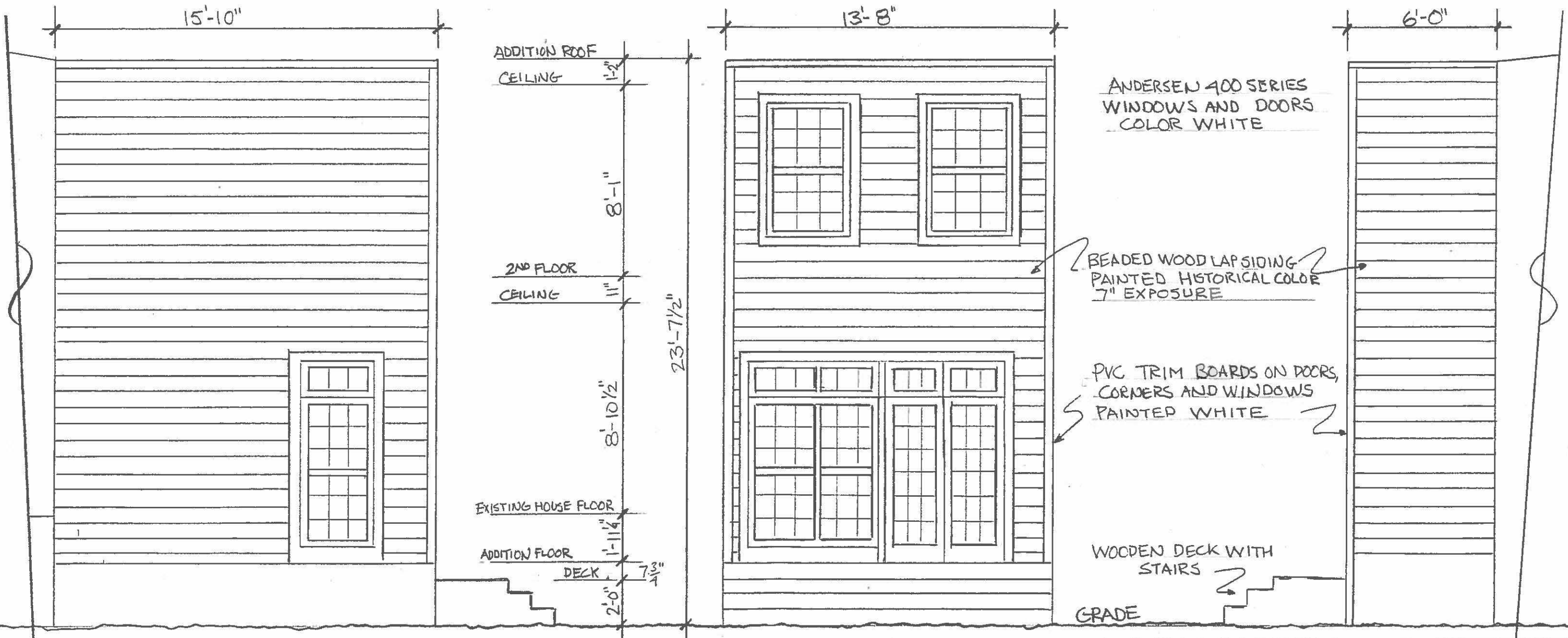

APPLICATION MATERIALS  
 BAR2015-00200/00201  
 733 S FAIRFAX ST  
 6/15/2015

ELEVATIONS FOR PROPOSED  
 ADDITION  
 1/4" = 1 FOOT

A4





PHOTO # 4  
THE PORCHES AT 725 S. FAIRFAX  
THAT WILL BE THE DESIGN  
FOR THE ADD ON PORCHES  
PROPOSED FOR 733

APPLICATION MATERIALS  
BAR2015-00200/00201  
733 S FAIRFAX ST  
6/15/2015



## Attachment A

### Door Hood

#### Type

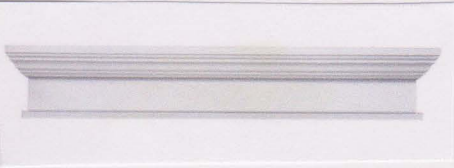

#### Specs

36"W x 39 1/2"OW x 7"H x 1"P

^ Crosshead with Bottom Trim

Item #: WCH36X7BT

★★★★★ (read 2 reviews) or [Leave a Review](#)

Width	Height	Projection	Overall Width
36"	7"	1 3/4"	39 1/2"

#### Facsimile



### Shutters

#### Facsimile

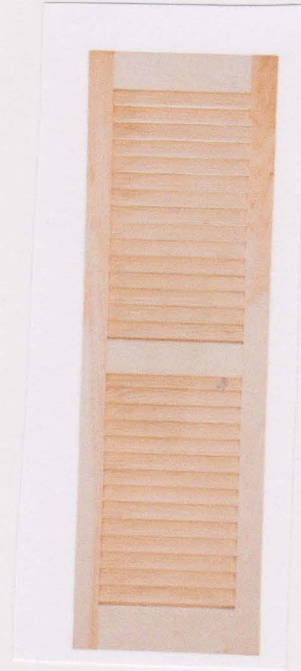

ADDRESS OF PROJECT: 733 S. FAIRFAX

TAX MAP AND PARCEL: 080.04202-17 ZONING: RESIDENTIAL

APPLICATION FOR: (Please check all that apply)

CERTIFICATE OF APPROPRIATENESS

PERMIT TO MOVE, REMOVE, ENCAPSULATE OR DEMOLISH  
(Required if more than 25 square feet of a structure is to be demolished/impacted)

WAIVER OF VISION CLEARANCE REQUIREMENT and/or YARD REQUIREMENTS IN A VISION CLEARANCE AREA (Section 7-802, Alexandria 1992 Zoning Ordinance)

WAIVER OF ROOFTOP HVAC SCREENING REQUIREMENT  
(Section 6-403(B)(3), Alexandria 1992 Zoning Ordinance)

Applicant:  Property Owner  Business (Please provide business name & contact person)

Name: CHARLES M SIPULA

Address: 7284 SOLITUDE ROAD

City: ST MICHAELS State: MD Zip: 21663

Phone: 703 304-8189 E-mail: CHUCK SIPULA @ HOTMAIL.COM

Authorized Agent (if applicable):  Attorney  Architect  \_\_\_\_\_

Name: \_\_\_\_\_ Phone: \_\_\_\_\_

E-mail: \_\_\_\_\_

Legal Property Owner:

Name: CHARLES M. SIPULA

Address: 7284 SOLITUDE RD

City: ST MICHAELS State: MD Zip: 21663

Phone: 703-304-8189 E-mail: CHUCK SIPULA @ HOTMAIL.COM

- Yes  No Is there an historic preservation easement on this property?
- Yes  No If yes, has the easement holder agreed to the proposed alterations?
- Yes  No Is there a homeowner's association for this property?
- Yes  No If yes, has the homeowner's association approved the proposed alterations?

EASEMENT IS NOT AFFECTED BY THE PROPOSED ALTERATIONS

If you answered yes to any of the above, please attach a copy of the letter approving the project.

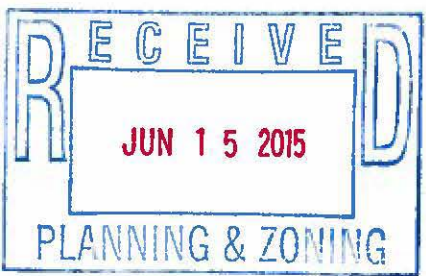



**NATURE OF PROPOSED WORK:** *Please check all that apply*

- NEW CONSTRUCTION
- EXTERIOR ALTERATION: *Please check all that apply.*
  - awning
  - doors
  - lighting
  - other \_\_\_\_\_
  - fence, gate or garden wall
  - windows
  - pergola/trellis
  - HVAC equipment
  - siding
  - painting unpainted masonry
  - shutters
  - shed
- ADDITION
- DEMOLITION/ENCAPSULATION
- SIGNAGE

**DESCRIPTION OF PROPOSED WORK:** *Please describe the proposed work in detail (Additional pages may*

The first floor back of the house is to be extended by 6 feet. The northern side of the house (approximately 3 feet in width) (see Photo #3 attached) which is set back from the majority of the width of the first floor back of the house (approximately 12.7 feet in width) (see Photo #2 attached) and the second story also set back from the very back of the first floor will be extended such that it is all parallel with the entire back of the newly extended house. The first story room created inside the back of the house would be stepped down to 2 feet within ground level by being stepped down inside the house by approximately 2 ft at approximately 15 ft inside of the extended back of the house. There would be 3 French doors across the entire of the back of the house opening onto two small steps (2 feet off ground level) leading to a redone garden. In the front of the house (see Photo #1 attached), a small, period authentic portico much like those that currently exist on numerous houses on the same and surrounding blocks would be added. The design of the portico to be added would be a replication of the portico a few doors down at 725 S Fairfax (see Photo #4 attached).

**SUBMITTAL REQUIREMENTS:**

Items listed below comprise the **minimum supporting materials** for BAR applications. Staff may request additional information during application review. Please refer to the relevant section of the *Design Guidelines* for further information on appropriate treatments.

Applicants must use the checklist below to ensure the application is complete. Include all information and material that are necessary to thoroughly describe the project. Incomplete applications will delay the docketing of the application for review. Pre-application meetings are required for all proposed additions. All applicants are encouraged to meet with staff prior to submission of a completed application.

Electronic copies of submission materials should be submitted whenever possible.

**Demolition/Encapsulation :** *All applicants requesting 25 square feet or more of demolition/encapsulation must complete this section. Check N/A if an item in this section does not apply to your project.*

- N/A Survey plat showing the extent of the proposed demolition/encapsulation.
- Existing elevation drawings clearly showing all elements proposed for demolition/encapsulation.
- Clear and labeled photographs of all elevations of the building if the entire structure is proposed to be demolished.
- Description of the reason for demolition/encapsulation.
- Description of the alternatives to demolition/encapsulation and why such alternatives are not considered feasible.

**Additions & New Construction:** Drawings must be to scale and should not exceed 11" x 17" unless approved by staff. All plans must be folded and collated into 3 complete 8 1/2" x 11" sets. Additional copies may be requested by staff for large-scale development projects or projects fronting Washington Street. Check N/A if an item in this section does not apply to your project.

- N/A Scaled survey plat showing dimensions of lot and location of existing building and other structures on the lot, location of proposed structure or addition, dimensions of existing structure(s), proposed addition or new construction, and all exterior, ground and roof mounted equipment.
- FAR & Open Space calculation form.
- Clear and labeled photographs of the site, surrounding properties and existing structures, if applicable.
- Existing elevations must be scaled and include dimensions.
- Proposed elevations must be scaled and include dimensions. Include the relationship to adjacent structures in plan and elevations.
- Materials and colors to be used must be specified and delineated on the drawings. Actual samples may be provided or required.
- Manufacturer's specifications for materials to include, but not limited to: roofing, siding, windows, doors, lighting, fencing, HVAC equipment and walls.
- For development site plan projects, a model showing mass relationships to adjacent properties and structures.

**Signs & Awnings:** One sign per building under one square foot does not require BAR approval unless illuminated. All other signs including window signs require BAR approval. Check N/A if an item in this section does not apply to your project.

- N/A Linear feet of building: Front: \_\_\_\_\_ Secondary front (if corner lot): \_\_\_\_\_.
- Square feet of existing signs to remain: \_\_\_\_\_.
- Photograph of building showing existing conditions.
- Dimensioned drawings of proposed sign identifying materials, color, lettering style and text.
- Location of sign (show exact location on building including the height above sidewalk).
- Means of attachment (drawing or manufacturer's cut sheet of bracket if applicable).
- Description of lighting (if applicable). Include manufacturer's cut sheet for any new lighting fixtures and information detailing how it will be attached to the building's facade.

**Alterations:** Check N/A if an item in this section does not apply to your project.

- N/A Clear and labeled photographs of the site, especially the area being impacted by the alterations, all sides of the building and any pertinent details.
- Manufacturer's specifications for materials to include, but not limited to: roofing, siding, windows, doors, lighting, fencing, HVAC equipment and walls.
- Drawings accurately representing the changes to the proposed structure, including materials and overall dimensions. Drawings must be to scale.
- An official survey plat showing the proposed locations of HVAC units, fences, and sheds.
- Historic elevations or photographs should accompany any request to return a structure to an earlier appearance.



**ALL APPLICATIONS:** Please read and check that you have read and understand the following items:

- I have submitted a filing fee with this application. (Checks should be made payable to the City of Alexandria. Please contact staff for assistance in determining the appropriate fee.)
- I understand the notice requirements and will return a copy of the three respective notice forms to BAR staff at least five days prior to the hearing. If I am unsure to whom I should send notice I will contact Planning and Zoning staff for assistance in identifying adjacent parcels.
- I, the applicant, or an authorized representative will be present at the public hearing.
- I understand that any revisions to this initial application submission (including applications deferred for restudy) must be accompanied by the BAR Supplemental form and 3 sets of revised materials.

The undersigned hereby attests that all of the information herein provided including the site plan, building elevations, prospective drawings of the project, and written descriptive information are true, correct and accurate. The undersigned further understands that, should such information be found incorrect, any action taken by the Board based on such information may be invalidated. The undersigned also hereby grants the City of Alexandria permission to post placard notice as required by Article XI, Division A, Section 11-301(B) of the 1992 Alexandria City Zoning Ordinance, on the property which is the subject of this application. The undersigned also hereby authorizes the City staff and members of the BAR to inspect this site as necessary in the course of research and evaluating the application. The applicant, if other than the property owner, also attests that he/she has obtained permission from the property owner to make this application.

**APPLICANT OR AUTHORIZED AGENT:**

Signature: 

Printed Name: CHARLES M. SYLLA

Date: 6/15/2015

**OWNERSHIP AND DISCLOSURE STATEMENT**

Use additional sheets if necessary

**1. Applicant.** State the name, address and percent of ownership of any person or entity owning an interest in the applicant, unless the entity is a corporation or partnership, in which case identify each owner of more than ten percent. The term ownership interest shall include any legal or equitable interest held at the time of the application in the real property which is the subject of the application.

Name	Address	Percent of Ownership
1.		
2.		
3.		

**2. Property.** State the name, address and percent of ownership of any person or entity owning an interest in the property located at 733 S. FAIRFAX (address), unless the entity is a corporation or partnership, in which case identify each owner of more than ten percent. The term ownership interest shall include any legal or equitable interest held at the time of the application in the real property which is the subject of the application.

Name	Address	Percent of Ownership
1.		
2.		
3.		

**3. Business or Financial Relationships.** Each person or entity listed above (1 and 2), with an ownership interest in the applicant or in the subject property is required to disclose any business or financial relationship, as defined by Section 11-350 of the Zoning Ordinance, existing at the time of this application, or within the 12-month period prior to the submission of this application with any member of the Alexandria City Council, Planning Commission, Board of Zoning Appeals or either Boards of Architectural Review.

Name of person or entity	Relationship as defined by Section 11-350 of the Zoning Ordinance	Member of the Approving Body (i.e. City Council, Planning Commission, etc.)
1.		
2.		
3.		

**NOTE: Business or financial relationships of the type described in Sec. 11-350 that arise after the filing of this application and before each public hearing must be disclosed prior to the public hearings.**

As the applicant or the applicant's authorized agent, I hereby attest to the best of my ability that the information provided above is true and correct.

6/15/15      CHARLES SIRUKA        
 Date                      Printed Name                      Signature