

RIGHT-OF-WAY LICENSE AGREEMENT

THIS RIGHT-OF-WAY LICENSE AGREEMENT (the “Agreement”) is entered into this [•] day of [•], 2022 (the “Effective Date”), by and between the City of Alexandria, Virginia, a municipal corporation and a political subdivision of the Commonwealth of Virginia (“City”), and Crown Castle Fiber LLC, a New York limited liability company (“Licensee”).

RECITALS

A. City is responsible for management of the Public Rights-of-Way (as hereinafter defined) and performs a wide range of vital tasks necessary to preserve the physical integrity of Public Rights-of-Way, to control the orderly flow of vehicles, to promote the safe movement of vehicles and pedestrians, and to manage the extensive gas, water, sewer, electric, cable television, telephone, telecommunications, and other facilities that are located in the Public Rights-of-Way.

B. City has the authority to authorize the occupancy of the Public Rights-of-Way, to obtain compensation for the use of public property, and to regulate the activities of occupants of the Public Rights-of-Way to provide for the safe, orderly, and efficient use of the Public Rights-of-Way, which includes the authority to regulate the time, location, and manner of attachment, installation, operation, and maintenance of Facilities (as hereinafter defined) located in the Public Rights of-Way, subject to Applicable Law (as hereinafter defined).

C. The Public Rights-of-Way are a valuable public resource that have required and will continue to require substantial investment by the City.

D. Licensee currently holds a Telecommunications Facility Franchise Agreement from the City dated September 1, 2021, which authorizes Licensee to install and operate certain wireless communications equipment attached to public utility poles (the “Wireless Facilities”).

E. Licensee also holds a License Agreement from the City dated December 1, 2019 (the “2019 Agreement”), pursuant to which Licensee and its predecessors have installed and Licensee currently operates fiber optic cables used to provide telecommunications services to commercial customers along certain defined routes in the City.

F. The 2019 Agreement expires on December 30, 2024, and Licensee desires to replace that agreement with a license for a term of five years after the Effective Date of this Agreement that will permit Licensee to install, maintain, operate, and control a Fiber Network (as hereinafter defined) in Public Rights-of-Way throughout the City for the purposes of transporting signals to and from Wireless Facilities and offering telecommunications services to commercial customers.

G. The Licensee and the City anticipate that the Licensee shall apply for a franchise authorizing the Licensee to use the Public Rights-of-Way for a period greater than five years, which will replace this Agreement.

H. Consistent with applicable law, the City desires to minimize inconvenience and disruption to the public, provide for the orderly and efficient use of the Public Rights-of-Way now and in the future, preserve adequate capacity for existing and future uses of the Public Rights-of-Way, and obtain compensation for the use of the Public Rights-of-Way.

I. The City intends to exercise, to the fullest extent permitted by applicable law, including without limitation Sections 15.2-2100 and 56-462 of the Code of Virginia, its authority with respect to the regulation of the occupation and use of the Public Rights-of-Way in connection with the construction and maintenance of the Licensee's Fiber Network.

J. Subject to Applicable Law, Licensee is willing to compensate City for use and occupancy of the Public Rights-of-Way by the Fiber Network.

NOW, THEREFORE, the City hereby grants a telecommunications License to Licensee subject to the following terms and conditions:

AGREEMENT

NOW, THEREFORE, in consideration of the promises and mutual covenants set forth herein and for other of good and valuable consideration, the receipt and sufficiency of which are hereby acknowledged, the parties agree as follows:

ARTICLE 1 DEFINITIONS

1.1. Definitions. The following terms, as used in this Agreement, have the following meanings (such meanings to be equally applicable to both the singular and plural forms of the terms defined):

(a) "2019 Agreement" has the meaning set forth in the preamble of this Agreement.

(b) "Additional Surety" has the meaning set forth in Section 8.2 of this Agreement.

(c) "Affiliate" means any legal entity directly or indirectly controlling, controlled by, or under common control with Licensee.

(d) "Agreement" has the meaning set forth in the preamble.

(e) "Applicable Law" means any or all federal, state, or municipal statutes, ordinances, rules, regulations, standards, and other laws, including City laws and federal, state and local final, non-appealable judicial and administrative decisions, that are now existing or hereafter adopted or amended from time to time, which apply to Licensee's services or other matters covered by this Agreement.

(f) “Arterial Rights-of-Way” has the meaning set forth in Section 4.11 of this Agreement.

(g) “Broadband Services” means the offering of broadband Internet access services to customers.

(h) “City” has the meaning set forth in the preamble.

(i) “City Code” means the Code of the City of Alexandria, 1981, as amended, and as it may be amended from time to time.

(j) “City Council” means the city council of the City of Alexandria.

(k) “Code of Virginia” means the 1950 Code of Virginia, as amended, and as it may be amended from time to time.

(l) “Construction Surety” has the meaning set forth in Section 4.5 of this Agreement.

(m) “Director” means any director of City’s Department of Transportation and Environmental Services, or the Director’s designee.

(n) “Effective Date” has the meaning set forth in the preamble.

(o) “Emergency” means a sudden or unexpected occurrence involving a clear and imminent danger, demanding immediate action to prevent or mitigate loss of, or damage to, life, health, property, or essential services.

(p) “Existing Facilities” means the Facilities of the Licensee installed and operated by the Licensee under the authority of the 2019 Agreement as of the Effective Date.

(q) “Facilities” means the tangible components of the Fiber Network, including without limitation all cables, optical fiber, poles, wires, customer service connections, electrical conductors, conduits, ducts, manholes, fixtures, appliances, and appurtenances that are placed or maintained by Licensee within the Public Rights-of-Way and used for purposes permitted by this Agreement. The Facilities do not include the Wireless Facilities.

(r) “Fiber Network” means the fiber optic communications network constructed and operated by the Licensee to provide Telecommunications Services within the City. The Fiber Network includes the Existing Facilities and all Facilities constructed under the authority of this Agreement.

(s) “General Surety” has the meaning set forth in Section 8.1 of this Agreement.

(t) “Licensee” has the meaning set forth in the preamble of this Agreement.

(u) “License” means the authorization to occupy and use the Public Rights-of-Way granted by this Agreement.

(v) "Like-for-Like" means the installation or relocation of Facilities in a like or similar manner of construction when compared to previously installed Facilities. For example, placement of Facilities underground, in locations where existing Facilities are constructed underground, are "Like-for-Like"; in the case of underground Facilities, conduit installations are to be replaced by conduit, and direct burial installations (where permitted) are to be replaced by direct burial.

(w) "Person" means an individual, corporation, limited liability company, partnership, association, trust or any other entity or organization, including a governmental or political subdivision, including City, or an agency or instrumentality thereof.

(x) "Proprietary Information" has the meaning set forth in Section 5.3 of this Agreement.

(y) "Public Rights-of-Way" means space in, upon, above, along, across, over, and below the public streets, roads, lanes, courts, ways, alleys, and boulevards, including all public street easements, and other City-owned property that is used as a public right-of-way, as the same now exist or may hereafter be established, that are under the legal jurisdiction and physical control of City. The term "Public Rights-of-Way" excludes all City parks, private property, and private easements.

(z) "Street Improvement" means the erection, construction, reconstruction, repair, upgrade, replacement, installation, maintenance, removal, widening, or related work performed in connection with streets, sidewalks, alleys, avenues, lanes, boulevards, or roads.

(aa) "Structures" includes buildings, signs, fences, tanks, poles, lines, fixtures, facilities, and any other tangible property or appurtenances owned or maintained by the City.

(bb) "Subscriber" means any Person who is lawfully receiving Telecommunications Services provided by Licensee within the territorial limits of the City.

(cc) "Telecommunications" means the transmission, between or among points specified by the user, of information of the user's choosing, without change in the form or content of the information as sent and received.

(dd) "Telecommunications Services" means the offering of Telecommunications for a fee directly to the public, or to such classes of users as to be effectively available directly to the public, regardless of the facilities used. The term "Telecommunications Services" shall not include Cable Services.

(ee) "Term" has the meaning set forth in Section 2.3 of this Agreement.

(ff) "Transfer" means any transaction in which: (1) there is any change, acquisition, or transfer of Control of Licensee; or (2) the License or any of the rights and/or obligations held by Licensee under the License are transferred to another Person. "Control" for purposes of this subsection means (i) ownership of more than 50% of the outstanding voting stock of a corporation or the voting equity interests of any other form of entity or (ii) the

possession of the power to direct or cause the direction of the management of Licensee, whether by contractual agreement, ownership of shares or other equity, or by statute.

(gg) “Wireless Facilities” has the meaning set forth in the preamble of this Agreement.

ARTICLE 2
GRANT OF AUTHORITY

2.1. Grant of License. City grants to Licensee a License to install, place, construct, maintain, operate, upgrade, repair, and replace Facilities within the Public Rights-of-Way subject to the conditions of this Agreement. This Agreement does not authorize Licensee to sublicense or sublease to any Person the right to occupy the Public Rights-of-Way for any purpose. Nothing in this Section 2.1 is intended to prevent Licensee from leasing its Facilities to any Person, provided that such Person is otherwise authorized under Applicable Law to engage in the activities for which such Person is leasing the Facilities. Licensee shall have no obligation under the preceding sentence to verify such authorization or monitor the activities of such Person, so long as Licensee has promptly notified City in writing of the lease.

2.2. Scope of License. The License authorizes Licensee to install, place, construct, maintain, operate, upgrade, repair, and replace a Fiber Network as necessary to provide Telecommunications Services. This License does not grant authority to Licensee to provide any other service, including cable service (as defined in Section 602(6) of the Cable Communications Policy Act of 1984), or video programming service (as defined in 47 U.S.C. § 522 (20)), within the City. Licensee shall have the right to provide services other than those listed in the preceding sentence, including without limitation, Broadband Services, provided that City reserves the right, in its sole discretion, to require a separate fee and a separate license or other authorization for any such other services, to the extent consistent with Applicable Law.

2.3. Term of License. The License commences on the Effective Date and expires five (5) years after the Effective Date (the “Term”), unless the License is replaced as provided in Section 2.4 of this Agreement or the License is terminated as provided in Section 10.2 of this Agreement.

2.4. Replacement with Franchise. This Agreement shall terminate and be replaced by a franchise agreement without further action by either party upon the effective date of a grant of a franchise by the City for a term longer than five (5) years that permits the Licensee to engage in the activities described in Section 2.2 hereof and such other activities as shall be set forth in the franchise agreement. At the time this Agreement is replaced by such a franchise agreement, all installations installed by Licensee under this Agreement that are permitted under the franchise agreement shall become installations installed pursuant to the franchise agreement for the duration of the term of the franchise agreement.

2.5. Non-Exclusive License. Nothing in this Agreement affects the right of City to grant any other Person a franchise or license to occupy and use the Public Rights-of-Way for the purpose of providing any form of communications service, or to engage in any other activity in the Public Rights-of-Way.

2.6. Right of City to Use Public Rights-Of-Way. Nothing in this Agreement affects the right of the City to occupy or use the Public Rights-of-Way in any fashion, except as otherwise expressly provided in this Agreement.

2.7. Use of City Structures. This License does not grant to Licensee use of City-owned Structures. The terms and conditions of Licensee's use of any City-owned Structure shall be set forth in a separate ordinance, agreement, lease, or other document, as appropriate.

2.8. License Subject to Rights of City and of Others; No Property Interest. The permission granted to Licensee pursuant to this Agreement shall be: (a) exercised by Licensee at Licensee's sole risk and expense; (b) subject to, and subordinate to, the rights of City to use the Public Rights-of-Way and City facilities exclusively or concurrently with any other Person; and (c) subject to all deeds, easements, dedications, conditions, covenants, restrictions, encumbrances, claims of title, and rights (whether recorded or unrecorded) of others, and also including all recorded or unrecorded rights of City. Nothing in this Agreement shall be deemed to grant, convey, create, or vest any real property interest in Licensee, including any fee or leasehold interest, easement, or vested right. Nothing herein contained shall be construed to require or compel City to maintain any portion of the Public Rights-of-Way for a period longer than that required by City's needs. Nothing herein shall restrict City from exercising its authority to vacate, abandon, or discontinue use of any portion of the Public Rights-of-Way and request the relocation or removal of Licensee's Facilities therefrom subject to the procedures, time periods, and remedies established herein.

2.9. Compliance with Laws. Except as specifically provided in this Agreement, Licensee shall comply with all local laws, rules, and regulations, and with all orders or other directives of City issued pursuant to this Agreement or with respect to City's management of its Public Rights-of-Way, subject to Applicable Law, including the obligation by City to ensure that its grant and administration of the License is nondiscriminatory and competitively neutral. City has the right to oversee, regulate and inspect the installation, upgrade, construction, repair, maintenance, and removal of Facilities in the Public Rights-of-Way in accordance with the provisions of this Agreement and Applicable Law. City reserves the right to adopt or issue such rules, regulations, orders, or other directives governing Licensee or Facilities as it shall find necessary or appropriate in the lawful exercise of its police power, and such other lawful orders as City shall find necessary or appropriate relating to management of the Public Rights-of-Way. No rule, regulation, order, or other directive issued pursuant to this section shall constitute an amendment to this Agreement.

2.10. Street Improvements. Licensee shall remove or relocate its Facilities within a Public Right-of-Way, at its own expense and within thirty (30) days of written notice provided by City, or such longer time as reasonably necessary given the scope of the relocation work, whenever City, in its sole discretion, determines that the Facilities disturb or interfere or conflict with (i) any Street Improvement; (ii) the operation, relocation, improvement, repair, construction or maintenance of present or future streets, alleys, avenues, roadways, bridges, or storm or sanitary sewer systems; or (iii) any other work performed by the City on City property adjacent to the Public Rights-of-Way. City shall provide, at no cost to Licensee, permits and alternative space in the Public Rights-of-Way for such relocation of Facilities, provided that such alternative space need not be in the exact same Public Right-of-Way but shall be in reasonable proximity to

the previous location, and such space shall be reasonably economically and technologically feasible for the relocation of such Facilities. City shall work with Licensee to modify designs as reasonably necessary to minimize the need to relocate Licensee Facilities. Any relocation of Facilities shall be in a Like-for-Like manner. If Licensee refuses or neglects to relocate its Facilities within thirty (30) days of written notice, or such longer time as reasonably necessary given the scope of the relocation work, after a second written notice from City, City may relocate the Facilities and Licensee shall pay to City the reasonable, actual costs incurred in the relocation of Licensee Facilities.

2.11. Requested Relocation of Licensee Facilities.

(a) Except for Street Improvement relocation of Facilities as specified above, within sixty (60) days, or such longer time as reasonably necessary given the scope of the relocation work, following the written request of any Person with the legal right to occupy the Public Rights-of-Way and a demonstrated need for Licensee to relocate in order that such Person may occupy the Public Rights-of-Way or move, repair, or perform alterations to existing facilities in the Public Rights-of-Way, Licensee shall remove, alter, or relocate Facilities..

(b) Licensee may impose a reasonable charge for any movement of its Facilities performed pursuant to this Section 2.11 and may require advance payment.

2.12. Emergency Removal or Relocation by City. If the Director, in the Director's reasonable discretion, determines that removal, relocation, or reconfiguration of any portion of the Licensee's Facilities is necessary in order to protect the public health, safety, or welfare, then the Licensee shall, at its sole cost and expense, remove, relocate, or reconfigure such portion of Licensee's Facilities subject to the procedures, time periods, and remedies established in Section 2.10. Should the Director determine that the public health, safety or welfare requires that the City undertake immediate maintenance, repair or other action as to the Licensee's Facilities, then the City may do so and the Licensee shall be responsible for all reasonable expenses. In such circumstances, the Director may take the measures required under this Section 2.12 without prior notice to Licensee, provided that the Director will (i) make reasonable efforts to provide prior verbal notice to the Licensee of such measures; and (ii) provide written notice to Licensee within 10 days of City's taking such measures.

2.13. Regulatory Approvals. The Licensee shall obtain all necessary approvals from the appropriate federal and state authorities to offer Telecommunications Services or any other services Licensee has the authority to provide under Applicable Law by means of the Facilities, and shall, upon the City's request, submit evidence of such approvals to the City.

2.14. Right-of-Way Closings. Nothing in this Agreement waives or releases the right of City in and to the Public Rights-of-Way. If all or part of the Public Rights-of-Way is eliminated, discontinued, closed or demapped, the Licensee shall cease with respect to such part of the Public Rights-of-Way upon the later to occur of (a) the effective date that such part of the Public Rights-of-Way becomes eliminated, discontinued, closed or demapped and any conditions specified by City are met; or (b) in the case of any transfer of title to such part of the Public Rights-of-Way to a private Person, the closing date of such transfer. City shall condition its consent to the elimination, discontinuance, closing or demapping on the agreement of any

Person to (x) grant an easement with rights of ingress and egress, at no additional charge, to Licensee providing the right to continue to occupy and use the real property being eliminated, discontinued, closed or demapped from the Public Rights-of-Way, and/or (y) reimburse Licensee for the reasonable costs of supporting, protecting, or relocating the affected Facilities.

2.15. Unauthorized Use. In the event of any use by Licensee of any property owned by or dedicated to City that is not authorized by this Agreement, Licensee shall, immediately upon notice by City, cease the use and remove all Facilities associated with such use. In addition, Licensee shall pay to the City a sum of five hundred dollars (\$500.00) for each day that the willful unauthorized use occurs.

2.16. Termination of 2019 Agreement. As of the effective date of the grant of the license under this Agreement, the 2019 Agreement is terminated and replaced by this Agreement. Any Facilities installed in the Public Rights-of-Way pursuant to the 2019 Agreement shall be deemed to be installations installed pursuant to this Agreement for the duration of the Term.

ARTICLE 3 COMPENSATION

3.1. Public Rights-of-Way Use Fee. The City has imposed a PROW Use Fee in accordance with Section 56-468.1(G) of the Code of Virginia. The City reserves the right to impose at any time on the Licensee any other fee or payment that may be allowed by federal or state law. The Licensee shall pay the PROW Use Fee, and any other fee or payment permitted to be imposed by state or federal law and duly enacted or levied in accordance with applicable law. The City has provided the Franchisee appropriate notice of the PROW Use Fee as required by Section 56-468.1(G) of the Code of Virginia. If the PROW Use Fee is eliminated, discontinued, preempted or otherwise is declared or becomes invalid, the Licensee and the City shall negotiate in good faith to determine fair and reasonable compensation to the City for use of the Public Rights-of-Way by the Licensee.

3.2. No Credits or Deductions. The compensation and other payments to be made: (a) shall not be deemed to be in the nature of a tax, and (b) except as may be otherwise provided by Section 56-468.1 of the Code of Virginia, shall be in addition to any and all taxes or other fees or charges that the Licensee is required to pay to the City or to any state or federal agency or authority, all of which shall be separate and distinct obligations of the Licensee.

3.3. Reservation of Rights. No acceptance by City of any payment shall be construed as an accord and satisfaction that the amount paid is in fact the correct amount, nor shall such acceptance of any payment be construed as a release of any claim that City may have for further or additional sums payable under the provisions of this Agreement. All amounts paid shall be subject to audit and recomputation by City.

3.4. Remedy for Underpayment. If, as a result of an audit or any other review, the City determines that the Licensee has underpaid fees for use of the Public Right-of-Way (or has underpaid the PROW Use Fee) in any twelve (12) month period by five percent (5%) or more, but less than Five Thousand Dollars (\$5,000.00), and the Licensee has had a reasonable opportunity to cure, then in addition to making full payment of the relevant obligation, the

Licensee shall reimburse the City for all of the reasonable costs associated with the audit or review, including all reasonable out-of-pocket costs for attorneys, accountants, and other consultants.

ARTICLE 4 FIBER NETWORK CONSTRUCTION

4.1. Scope of System. Licensee shall commence construction of the Fiber Network in accordance with the Initial Construction Plan (as defined below), subject in all respects to the grant by City or other governmental entities of any necessary authorizations or permits for commencement of construction. Construction of the Fiber Network shall be at Licensee's sole cost and expense and at no cost to City.

4.2. Placement of Facilities. Licensee shall comply with all requirements of the City Code and City policies that govern the placement of Facilities in the Public Rights-of-Way. In placing its Facilities underground, Licensee shall also comply with the construction techniques described in Exhibit A or any construction technique(s) subsequently approved for use by the Director. In the event of any conflict between any applicable provision of the City Code or a City policy and Exhibit A, Exhibit A shall control, provided, however, that in the event of such a conflict, the City reserves the right to require that Licensee propose one or more alternative methods or designs for the City to consider and approve. All Facilities in the Public Rights-of-Way shall be placed underground. Licensee shall maintain and repair or replace all elements of the Fiber Network installed in the Public Rights-of-Way, for as long as the Fiber Network remains in the Public Rights-of-Way.

4.3. Initial Construction Plan. As of the Effective Date, Licensee has submitted to the City a schematic plan showing existing facilities, proposed future fiber routes, and construction methods. The City has commented on this plan and the Licensee has addressed the City's comments. The proposed fiber routes are divided into five zones (each, a "Construction Zone") as described in Exhibit B (the "Initial Construction Plan"). Licensee shall commence construction as soon as reasonably practicable after the Effective Date, subject in all respects to the grant by the City of all necessary permits for the commencement of construction, as further described in Section 4.9. Licensee shall submit a construction permit application (or applications) for each Construction Zone, which shall each include permit-level construction drawings. The City will review each such application in accordance with its standard procedures, except as modified by Section 4.9.

4.4. Construction Coordination. Before commencement of any construction, Licensee and its construction contractor shall provide a schedule of construction to City and request a pre-construction meeting with staff to closely coordinate all activities within the Public Rights-of-Way. Following the commencement of construction, Licensee and City shall hold construction coordination meetings weekly until construction as proposed in the Initial Construction Plan is completed, unless Licensee and City determine that any such meeting is not required. At each such meeting, Licensee shall provide City with an update on the progress of construction as proposed in the Initial Construction Plan, and the parties shall discuss matters of mutual concern related to construction of the Fiber Network, such as permitting, design, construction methods and progress, and buildout timelines. In addition, Licensee shall make commercially reasonable

efforts to respond to any request for information on progress in construction by City within ten (10) days of such request.

4.5. Construction Surety. Prior to commencing any construction, excavation, or installation under this Agreement, Licensee shall furnish City with a form of surety to ensure faithful performance of Licensee's construction obligations under this Agreement in the amount of five hundred thousand dollars (\$500,000.00) (the "Construction Surety"). The form of the surety shall be in a form reasonably satisfactory to the City Attorney. Licensee shall maintain the Construction Surety in place until Licensee has completed construction of the Fiber Network. For the avoidance of doubt, construction of the Fiber Network does not include construction or maintenance of customer service connections or "drops." Upon completion of construction of the Facilities proposed to be constructed under the Initial Construction Plan, the Licensee shall provide City with written notice, and City shall return or release the Construction Surety within thirty (30) days thereafter, provided that Licensee shall thereupon restore the Construction Surety if required by the City in connection with subsequent construction and shall provide any other form of surety otherwise required by this Agreement or Applicable Law. The Construction Surety shall be deemed to satisfy any requirements of this Agreement or City Code that would otherwise apply to the construction of the Fiber Network.

4.6. Subsequent Construction. Should the Licensee desire to extend the Fiber Network by constructing additional Facilities after completion of the work performed under the Initial Construction Plan, the Licensee shall apply for and obtain all applicable permits required by the City. The City reserves the right to require the Licensee to submit a proposed construction plan for any such project, to review and comment on the plan, and to require Licensee to restore the Construction Surety.

4.7. Contents of Construction Plans. The Initial Construction Plan and all subsequent construction plans are to include locations of all underground and above-ground facilities; the methods of attachment to culverts and bridges, with any structural calculations needed to enable City's review of appropriateness, construction details, and specifications; E&S control plans; and restoration details.

4.8. Publicizing Proposed Construction and Other Work. Licensee shall publicize scheduled work related to the construction of the Fiber Network by providing written notice of such work to the Director at least thirty (30) days before the commencement of such work. No later than ten (10) days prior to beginning construction along any portion of the Public Rights-of-Way, Licensee shall provide a first notification to those Persons affected by such construction. Licensee shall provide a second notification not less than three (3) days prior to construction. In providing such notice to all affected Persons, Licensee may, in its discretion, deliver flyers or door hangers, or use direct mail or bill inserts. Upon the request of the Director, Licensee shall hold community meetings, which shall be scheduled with the assistance of the Director and other City agencies, as reasonably necessary to provide the community notice of such planned construction work. In addition, the Licensee shall notify affected Persons by mail, distribution of flyers and/or door hangers to residences to provide adequate notice to affected Persons. The Director shall approve the notification before it is distributed to the affected Persons to insure, at a minimum, that adequate information is provided to notify the affected Persons of the Construction work that is to be undertaken, together with the name and telephone number of a

contact person designated by Licensee to respond to questions that affected Persons may raise. In addition to the above, the Licensee shall make a reasonable effort to contact the property owner or in the case of residential property, the property occupant.

4.9. Fiber Network Construction Permits.

(a) Licensee shall be subject to City's general permit requirements and shall pay the established fee for all such permits. All construction in the Public Rights-of-Way by the Licensee shall be subject to the City's general permit requirements, and Licensee shall comply with all reasonable requirements established by the Director. The Licensee shall, at the time it applies for a construction permit, submit to the Director the accompanying information which (a) shall identify the specific location within each Public Rights-of-Way in which the proposed construction is to take place, (b) shall describe the Facilities to be installed in each Public Rights-of-Way and the construction techniques to be used in accomplishing the installation, (c) shall provide any required traffic control plan that shall be reviewed and approved by the Director, (d) shall state, as to each Public Right-of-Way, the dates on which the proposed construction is to commence and on which the proposed construction is anticipated to be completed, (e) shall verify that Licensee has obtained, or will obtain prior to commencing the construction, approval of the placement of the Facilities and any required permits from any other entity (not including departments or agencies of the City) whose approval is required by law, and (f) shall provide other reasonable information the Director reasonably requests. The Director shall have the discretion, which is to be reasonably exercised, to determine the timing of the proposed construction, taking into account the dates requested by the Licensee and other planned and/or on-going construction work in the affected Public Rights-of-Way. The Licensee agrees that construction of Facilities in Public Rights-of-Way shall be done in such locations and in such manner so as not to unreasonably interfere with existing water, gas, sewer pipes, traffic signal, street light and other utilities and conduits in the Public Rights-of-Way, or with the public's use of the Public Rights-of-Way, and shall, to the maximum degree feasible, be coordinated with any construction being simultaneously undertaken at the same location by another provider of telecommunications or of cable service or by a provider of utilities.

(b) City will work diligently and in good faith with Licensee to ensure an effective and efficient construction permit approval process. City shall respond to Licensee's permit applications as soon as practicable and not more than forty-five (45) calendar days from the date of submission by Licensee. If the permit is approved, Licensee may proceed with construction. If a permit is denied, City shall describe in writing why the permit was reasonably denied and specify any required plan modifications or additional information necessary for approval. City shall respond to the resubmission for a previously denied construction permit within fifteen (15) business days of the resubmission. All construction permits shall remain open for one hundred and eighty (180) days, and City shall grant reasonable sixty (60) day extensions for good cause shown. Construction permits, along with any required traffic control plans, shall be approved within the time frames above, and there shall be no separate approval process for traffic control plans.

(c) Licensee agrees that construction of Facilities in Public Rights-of-Way shall be done in such locations and in such manner so as not to unreasonably interfere with existing water, gas, sewer pipes, traffic signal, street light and other utilities and conduits in the Public

Rights-of-Way, or with the public's use of the Public Rights-of-Way, and shall, to the maximum degree feasible, be coordinated with any construction being simultaneously undertaken at the same location by a provider of telecommunications, cable service, or utilities.

4.10. Parking Permits for Fiber Network Construction. City shall provide Licensee with parking permits at specific locations for all construction work, at the established fee for such permits.

4.11. Maintenance in Arterial Rights-of-Way. Licensee may perform maintenance on Facilities located in or along Arterial Rights-of-Way (as defined below) from time to time without prior approval of the Director as long as neither the component of the Facilities being worked on, nor any of the Facilities or workers involved in such maintenance, are located on the travel, parking, curb or sidewalk portion of the Arterial Rights-of-Way. "Arterial Rights-of-Way" are designated by City and City has provided Licensee with a current listing of designated Arterial Rights-of-Way. City shall provide updates to the listing upon Licensee request. At least thirty (30) days prior to performing maintenance on any Facilities located on the travel, parking, curb or sidewalk portion of the Arterial Rights-of-Way, Licensee shall (a) inform the Director in writing of the location at which it intends to perform such maintenance, (b) provide reasonable information the Director requests, and (c) obtain either a verbal or written approval of the maintenance from the Director or their designee. In performing maintenance, Licensee shall comply with all reasonable requirements established by the Director. Notwithstanding the foregoing, Licensee must obtain appropriate permits from City for any work that involves excavation, and for any activity that affects motorized or pedestrian traffic within the Public Rights-of-Way, or when required by the Director.

4.12. Maintenance in Non-Arterial Rights-of-Way. Licensee may perform maintenance on Facilities located in the Public Rights-of-Way, other than Arterial Rights-of-Way, without prior approval of the Director. In performing maintenance, Licensee shall comply with all reasonable requirements established by the Director. Notwithstanding the foregoing, Licensee must obtain appropriate permits from City for any work that involves excavation, and for any activity that affects motorized or pedestrian traffic within the Public Rights-of-Way, or when required by the Director.

4.13. Removal. Licensee may, at any time, in the exercise of its sole and absolute discretion, remove any or all of the Facilities from the Public Rights-of-Way. When performing any aspect of removal where the Facilities being worked on or any of the equipment or workers involved in the removal are located on the travel, parking, curb or sidewalk portion of a street, or any other portion of the Public Rights-of-Way, Licensee shall comply with all procedures applicable to maintenance, as set forth above in Sections 4.11 and 4.12.

4.14. Damage to and Restoration of the Public Rights-of-Way and Other Property.

(a) Subject to subsection (b) (in the case of repavement or resurfacing), if, in the course of construction or maintenance or otherwise dealing with any of the Facilities, Licensee damages any pavement, street, alley, sidewalk, sewer, water or other pipe, in or adjacent to the Public Rights-of-Way, or any other public property, real or personal, including any Structure, belonging or dedicated to City, Licensee shall promptly replace, repair or restore

any damaged property to its prior condition at its own cost and expense. If winter weather conditions or the availability of materials delay permanent pavement restoration, Licensee shall make an acceptable temporary patch. When weather conditions permit or materials become available, Licensee shall make permanent restoration as noted above. Licensee shall also maintain such temporary patches until a permanent repair is completed. If Licensee shall default in this obligation, City may cure the default itself, and may charge to Licensee the reasonable cost it incurs in curing the default; provided, that prior to performing any work to cure a default, City shall give Licensee written notice of the default and a period of ten (10) business days from the date of the notice in which to initiate action to cure the default and a period of forty-five (45) days in which to complete the cure; provided further, that these ten (10) and forty-five (45) day periods will be extended by the Director for a reasonable amount of time if a cure of the default cannot reasonably be commenced, or the default cannot reasonably be cured, within such respective periods, and Licensee has diligently pursued commencement of, or completion of, a cure during the period as applicable. Notwithstanding the foregoing, if the Director determines, in the Director's sole discretion consistent with Applicable Law, that the damage threatens the public health or safety, City may commence the repair of the damage and assess its costs upon Licensee; provided, that, prior to commencing such repair work, City shall make a reasonable effort to provide Licensee with telephonic notice and an opportunity to immediately repair the damage itself. In the event Licensee is unable to, or otherwise fails to, repair the damage within the time frames noted above and City performs the repair work, City shall, immediately upon completion of the work, provide Licensee with written notice of the work it has performed, and also shall, reasonably soon after the completion of the work, provide Licensee with a statement of the reasonable costs City incurred in performing the work.

(b) Unless otherwise provided in the construction specifications set forth in Exhibit A, if there are any street cuts or other disturbances of the surface of the Public Rights-of-Way as a result of any construction or maintenance by the Licensee under this Agreement, Licensee shall repave or resurface the Public Rights-of-Way in accordance with the then-existing standards set forth by the Director.

(c) Licensee shall warrant for two (2) years, commencing on the date any work performed under this Section 4.14 is approved by City, that any such replacement or repair (excluding trees, grass and other plantings) conforms to written City specifications and requirements made available to Licensee. If Licensee does not commence such replacement or repair after thirty (30) days' notice or reasonable time frame given the scope of work and availability of materials, the City may make such replacement or repair and the Licensee shall pay the reasonable cost of the same.

(d) Any costs assessed upon Licensee under this Section 4.14 shall be paid to City within thirty (30) days of the assessment.

4.15. Safety Precautions. Licensee shall maintain in good and safe condition all Facilities it places within Public Rights-of-Ways. Licensee shall, at its own cost and expense, undertake to prevent accidents at its work sites in, at or on the Public Rights-of-Way, including

the placing and maintenance of proper guards, fences, barricades, watchmen and suitable and sufficient lighting, in accordance with federal and state law.

4.16. Quality. All work involved in the placement and maintenance of Facilities shall be performed in a safe, thorough, and reliable manner in accordance with industry, professional, state, and federal mandated standards and using materials of good and durable quality. The Fiber Network shall also be maintained in accordance with the highest industry standards and procedures, using materials of good and durable quality. Materials used in restoration and repair of the Public Rights-of-Way shall comply with the Virginia Department of Transportation Road and Bridge Inspections Specifications (2020) and Details (2016, revised May 2020 with Revisions) and the Virginia Department of Transportation approved materials list. If, at any time, it is determined by City or any other agency or authority of competent jurisdiction that any Facilities violate in any material respect any health or safety law or regulation, then Licensee shall, at its own cost and expense, promptly correct all such conditions.

4.17. No Obstruction. Except for Emergencies, routine maintenance in a non-Arterial Right-of-Way, and work related to customer service connections, Licensee shall not obstruct traffic to any street, road, or other Public Rights-of-Way within the corporate limits of City without the prior consent of City. Facilities of Licensee in the Public Rights-of-Way shall be located so as to cause minimal interference with any use of the Public Rights-of-Way and adjoining property.

4.18. . Emergency. During an Emergency, Licensee may take all reasonable measures to restore service and alter its Facilities as necessary to ensure the safety of the residents of City. As soon as practicable, Licensee shall notify the Director or their designee of any emergency necessitating an obstruction. Licensee shall coordinate its activities in responding to the emergency with the Director or its designee.

4.19. Protection of the Public Rights-of-Way. In connection with the construction and maintenance of Facilities by Licensee, Licensee shall, at its own cost and expense, protect the Public Rights-of-Ways and any City-owned Structures thereon, thereunder or thereover, and shall obtain the prior approval of City, pursuant to this Agreement, before altering the Public Rights-of-Way or any such Structures. Any such alteration shall be made by Licensee, at its sole cost and expense, in a manner prescribed by City to protect the Public Rights-of-Way and any City-owned Structures thereon.

4.20. Private Property. Licensee agrees to restore all private property affected by construction of the Fiber Network to the condition it was in prior to commencement of construction, at no expense to the affected property owner. Licensee also shall repair any and all damage to any private property resulting from the installation, maintenance, or operation of the Fiber Network at no expense to the affected property owner and to the reasonable satisfaction of the property owner.

4.21. Public Safety. In the case of fire, disaster or other emergency, or to correct an unsafe work condition as determined by City in its sole discretion, City may cut or move Licensee's Facilities as reasonably necessary to protect public health or safety. City will make every reasonable effort to consult with Licensee prior to any such cutting or movement of

Facilities and Licensee shall be given the opportunity to perform such work itself. City shall have the obligation to protect Licensee's Facilities to the maximum extent reasonable under the circumstances. All costs to repair or replace Facilities shall be borne by Licensee.

4.22. Public Relations Contact. Licensee shall (i) designate a public relations contact; (ii) provide a phone number and email for that contact to City; and (iii) post the contact information prominently on its website on a page on which Licensee's Alexandria fiber project and services are being advertised. The contact will be responsible for responding to any and all questions, complaints and concerns from the general public during construction of the Fiber Network.

ARTICLE 5 REPORTS AND RECORDS

5.1. General Reports. Licensee shall cooperate with City with respect to administration of this Agreement. To that end, and subject to the provisions of this Article concerning Proprietary Information, Licensee will make available to City upon request such records, reports, books of account, documents, and other information ("Records"), as Licensee maintains in the ordinary course of business and that may be reasonably necessary for the administration or enforcement of this Agreement and in such form and manner, and at such place, as reasonably requested by City. Licensee shall make such Records available to City for inspection and copying within thirty (30) days after receipt of written notice. All Records that pertain to the PROW Use Fee or any fee or tax that may be the subject of an audit by the City shall be retained by the Licensee for such period of time as is set forth in the statute of limitations applicable to the fee or tax at issue.

5.2. Documentation and Maps. Licensee shall provide City with as-built maps for each permit within sixty (60) days following completion of construction and final inspections, in a standard electronic format to be designated by the Director. Licensee shall provide an up-to-date strand map of its facilities annually, within thirty (30) days following the anniversary of the Effective Date, to assist City in monitoring compliance and assessing areas for possible expansion of the Fiber Network. Licensee shall also provide maps upon request in connection with the City's evaluation of specific requests for service from residents.

5.3. Treatment of Proprietary Information. Access by City to any of the documents, records or other information covered by this Agreement shall not be denied by Licensee on grounds that such documents, records, or information are alleged by Licensee to contain Proprietary Information. For purposes of this Agreement, "Proprietary Information" means that portion of documents, records or other information which is in the possession of Licensee which is not generally available to the public and which Licensee desires to protect against unrestricted disclosure or competitive use. If Licensee claims that documents, records, or other information requested by City contain Proprietary Information, City agrees to review the Proprietary Information at Licensee's premises in the City and, in connection with such review, to limit access to the Proprietary Information to those individuals who require the Proprietary Information in the exercise of City's rights under this Agreement. To the extent permitted by Applicable Law, City will not disclose Proprietary Information to any Person. All documents, records or other information which is disclosed by Licensee to City and which Licensee claims

is Proprietary Information shall be labeled as "Proprietary" if such information is in writing, and if such information is oral, it shall be identified as "Proprietary" prior to disclosure. The labeling of documents, records, or other information as "Proprietary" shall be the sole responsibility of Licensee. The protections offered to Licensee by this Section 5.3 shall not apply to documents, records or other information which: (a) are made public or become available to the public other than through a disclosure by City or its representatives; (b) are already in the possession of City prior to the Effective Date; (c) are received from a third party who has the right to make such disclosure without any obligation of confidentiality to Licensee or other restriction on disclosure; (d) are independently developed by City; or (e) are disclosed pursuant to a valid court order or Applicable Law.

5.4. Survival. The provisions of Section 5.3 shall survive expiration, termination, or revocation of this Agreement for a period of five (5) years.

ARTICLE 6 LIABILITY AND INSURANCE

6.1. Coverage Limits. Licensee, at its sole expense, shall obtain and maintain the types of coverages and limits indicated below throughout the Term of this Agreement, providing coverage for claims arising from the exercise of the permission granted hereunder by City. These amounts of coverage will not constitute any limitations or cap on Licensee's indemnification obligations under this Agreement. The City, its elected officials, officers, agents, and employees make no representation that the limits of the insurance specified to be carried by Licensee pursuant to this Agreement are adequate to protect Licensee. If Licensee believes that any required insurance coverage is inadequate, Licensee will obtain such additional insurance coverage, as Licensee deems adequate, at Licensee's sole expense.

(a) Commercial General Liability Insurance. \$2,000,000 per occurrence for bodily injury and property damage and with \$5,000,000 general aggregate, including premises and operations, personal and advertising, products and completed operations, contractual liability, and independent contractors.

(b) Automobile Liability. \$2,000,000 combined single-limit per accident for bodily injury and property damage for each owned, non-owned, and hired vehicle.

(c) Workers' Compensation and Employer's Liability. Virginia Statutory Workers' Compensation coverage, including Virginia benefits and employer's liability with limits of \$500,000 per accident for Bodily Injury by Accident and \$500,000 policy limit/\$500,000 each employee for Body Injury by Disease.

6.2. Contractors' Coverage. Licensee shall require all contractors who will perform work in connection with the installation, construction, operation or maintenance of Licensee's Facilities, including without limitation customer service drops, to procure and maintain Virginia statutory limits of Worker's Compensation insurance. Licensee shall provide City satisfactory evidence of such coverage before each contractor begins work.

6.3. Certificates; Noncancellation; Additional Insureds. Prior to the beginning of the Term, and annually thereafter, Licensee shall furnish City with certificates of insurance and

blanket additional insured endorsements as required by this Agreement. Each policy shall provide, among other things, that the actions or omissions of any insured party shall not invalidate the policy as against any other insured party or otherwise adversely affect the rights of any other insured party under the policy. The insurance required to be carried by Licensee herein shall be with an insurance company licensed, authorized or permitted to do business in the Commonwealth of Virginia and rated not lower than A:VII in the A.M. Best Rating Guide. Upon receipt of notice from its insurer(s), Licensee shall provide City with at least thirty (30) days' prior written notice to City of cancellation of any required coverage. City, its elected and appointed officials, officers, and employees shall be included as additional insureds as their interest may appear under this Agreement under all coverage maintained by Licensee hereunder except workers' compensation and employer's liability. If the policy requires an endorsement to include the indicated Persons as additional insureds, the blanket additional insured endorsement must accompany the certificate of insurance. Coverage afforded under this Section 6.3 shall be primary as respects City, its elected and appointed officials, officers, and employees.

6.4. Increased Insurance Coverage. In the event of any changed circumstances following the Effective Date related to the activities of the Licensee in the Public Rights-of-Ways, which materially affect the risks associated with the activities of the Licensee permitted or authorized by the City, after consulting with the Licensee, may alter the minimum limitation of liability insurance policy or policies or other evidence of insurance.

ARTICLE 7 INDEMNIFICATION

7.1. Hold Harmless and Indemnification.

(a) Licensee shall, at its sole cost and expense, fully indemnify, defend, and hold harmless City, and its officers, employees, and agents, from and against any and all losses and any and all claims, suits, actions, liability and judgments for damages or other relief arising out of property damage, bodily injury, or death arising from the installation, construction, operation or maintenance of Licensee's Facilities, and against any liability arising out of or in connection with the acts or omissions of Licensee or any officer, employee, or agent thereof, in the installation, construction, operation or maintenance of Licensee's Facilities or the provision of services by means of the Facilities. The indemnity obligation of Licensee under this section shall include, but is not limited to, providing legal representation and otherwise defending City and City officers, employees and agents against any claim, suit, or action covered by this indemnification. If a suit or action for which City or its officers, employees and agents are entitled to be indemnified and held harmless shall be brought against City or one or more of its officers, employees or agents, either individually or jointly with Licensee, or City receives any demand or notice threatening any such suit or action, City shall promptly provide Licensee with written notice of such demand, notice, claim, suit, or action. City may participate in Licensee's defense directly, at its own expense.

(b) If a final judgment is obtained against City or one or more of its officers, employees or agents in a suit or action, either independently or jointly with Licensee, for which City and its officers, employees and agents are entitled to be indemnified and held harmless

under this section, Licensee shall pay every judgment, including all costs and attorneys' fees, entered against City and any of its officers, employees, and agents.

(c) Licensee shall be entitled to settle a claim brought in a suit or action for which City and its officers, employees and agents are entitled to be indemnified and held harmless under subsection (a). Licensee must obtain the prior written approval of City for any settlement of such claims against City, which approval shall not be unreasonably withheld, conditioned, or delayed; provided, however, that City shall not withhold consent to settlement when the settlement imposes no continuing obligations on City and includes a release of City from all claims.

(d) The indemnities in this section shall survive the expiration of or earlier termination of this Agreement for a period of five (5) years.

7.2. Liability Not Limited. The legal liability of Licensee to City and any Person for any of the matters that are the subject of the liability insurance policies or other evidence of insurance required above, including, without limitation, Licensee indemnification obligations as set forth in this Agreement, shall not be limited by such insurance policies nor by the recovery of any amounts thereunder, except to the extent necessary to avoid duplicative recovery from or payment by Licensee.

7.3. Liability of City. Neither the City nor its elected and appointed officials, officers, employees, or agents shall be responsible to the Licensee for any liability as a result of or in connection with the protection, breaking through, movement, removal, alteration, or relocation of any Facilities by or on behalf of the Licensee or the City in accordance with this Agreement or in connection with any emergency related to the health and safety of the public. City and its elected and appointed officials, officers, employees, and agents shall have no liability to Licensee pursuant to this Agreement or Applicable Law, arising from the exercise by City of the rights of City to approve or disapprove the grant, termination, amendment, renewal or Transfer of the Franchise, or to otherwise modify all or any part of this Agreement. Neither City nor its officers, employees, or agents shall be responsible for any liability of Licensee, any Affiliate or any other Person, arising out of or in connection with acts or omissions of Licensee or any employee, agent or subcontractor thereof, in the construction or maintenance of Facilities or the provision of services by means of the Facilities. The City and its elected and appointed officials, officers, employees and agents shall have no liability to the Licensee, any Affiliated Person or any other Person for any other damages as a result of the exercise of any right of the City pursuant to this Agreement or Applicable Law. City shall not be liable to Licensee or to any other Person for any interruption in Licensee's services or for any interference with the operation of Licensee's Facilities arising from City's use of any City-owned property, whether or not affixed to the land, or the Public Rights-of-Way or from any other action of the City, its officers, agents, and employees, provided that the foregoing is not caused by the negligence, willful misconduct, or breach of this Agreement by City.

7.4. Consequential Damages. Notwithstanding any other provision contained in this Agreement, in no event shall either party be liable for any special, incidental, consequential, indirect, or exemplary damages.

ARTICLE 8 SURETY

8.1. General Surety. Upon the release of the Construction Surety, Licensee shall furnish City with a surety bond to ensure faithful performance under this Agreement, in the amount of two hundred fifty thousand dollars (\$250,000.00) ("General Surety"). The General Surety shall be written by a corporate surety or bank reasonably acceptable to City and authorized to do business in the Commonwealth of Virginia. Within sixty (60) days after the date of any notice of cancellation of the General Surety, Licensee shall obtain and deposit with City a replacement surety that complies with the requirements of this Section 8.1 and that is reasonably acceptable to City. Such replacement surety shall show continuous coverage as required by this Section 8.1 from the effective date of cancellation of the prior surety forward. City shall return or release the General Surety within twelve (12) months following the termination of this Agreement.

8.2. Additional Surety. In addition to the General Surety, the Director may also require Licensee to submit reasonable additional surety in connection with specific construction or maintenance, in accordance with Applicable Law and City's standard permitting procedures ("Additional Surety"). Licensee shall only be required to maintain such Additional Surety for the duration of such specific construction or maintenance.

8.3. Changed Amount. At any time during the Term, City may, acting reasonably, require Licensee to increase the amount of the General Surety, and Licensee may request that City decrease the amount of the General Surety, if City finds (whether through its own investigation or by request of Licensee) that new factors applicable to Licensee's activities in the Public Rights-of-Way exist that reasonably necessitate or justify a change in the amount of the General Surety. Such new facts may include, but are not limited to, such matters as material changes in Licensee's activities in the Public Rights-of-Way; material changes in the amount and location of Facilities; Licensee's recent record of repeated non-compliance with the terms and conditions of this Agreement; and material changes in the amount and nature of construction, maintenance, or other activities to be performed by Licensee in the Public Rights-of-Way pursuant to this Agreement.

8.4. Purpose of Construction Surety, General Surety and Additional Surety. The Construction Surety, General Surety and Additional Surety shall serve as security for:

(a) The faithful performance by Licensee of all material terms, conditions and obligations of this Agreement;

(b) Any expenditure, damage, cost, or loss incurred by City occasioned by Licensee's failure to comply with its obligations pursuant to this Agreement and/or with all rules, regulations, orders, permits and other directives of City relating to construction or maintenance of the Facilities, or management of the Public Rights-of-Way;

(c) the removal of Facilities from the Public Rights-of-Way at the termination of the Agreement, at the election of the City, pursuant to Section 10.3 of this Agreement; and

(d) Any loss or damage to the Public Rights-of-Way or any property of City during the installation, upgrade, construction, repair, maintenance, or removal of Facilities, during any time in which such surety remains in place.

8.5. Claims against the Construction Surety or the General Surety. City shall provide not less than thirty (30) days' notice of City's intent to make a claim against the Construction Surety or General Surety. Claims against the bond shall be governed by the terms of the bond, which shall be satisfactory to the City Attorney. Payment to the City under the terms of the Construction Surety or the General Surety shall not be deemed a cure of the default(s) that led to the claim and payment. City may not seek recourse against either the Construction Surety or the General Surety for any costs or damages for which City has previously been compensated through a payment under the Construction Surety or the General Surety or otherwise by Licensee. Payment of any claim under the Construction Surety or the General Surety shall constitute a credit against the amount of the applicable liability of Licensee to City, but only to the extent of such payment.

8.6. Replenishment of the Construction Surety or the General Surety. The terms of the Construction Surety and the General Surety shall provide that, if a claim is paid under the Construction Surety or the General Surety, the full amount of the respective surety shall remain in effect as surety for any subsequent claims that may be made by City.

8.7. Not a Limit on Liability. The obligation to perform and the liability of Licensee pursuant to this Agreement shall not be limited by the acceptance of either the Construction Surety or the General Surety required by this Article.

**ARTICLE 9
ASSIGNMENT OR TRANSFER OF LICENSEE'S FRANCHISE**

9.1. Restriction on Sale or Transfer of License. Licensee may, at any time, following written notice to City, consummate a Transfer to any Affiliate of Licensee. The prior written consent of the City shall be required for any other Transfer.

9.2. Requirements of Sale or Transfer. In the event Licensee requests consent for a Transfer pursuant to Section 9.1, Licensee shall provide City in such request for consent with reasonable evidence that the successor in interest or purchaser has the resources and ability to fulfill the obligations of this Agreement. No Transfer, whether subject to the consent of City or not, shall be valid unless the assignee or transferee has agreed in writing that it will abide by and accept all terms of this Agreement and all other agreements between City and Licensee, and that it will assume the obligations, liabilities, and responsibility for all acts and omissions, known and unknown, of the previous Licensee under this Agreement. Each transferee or assignee shall deliver to City a signed Assumption Agreement to that effect in form and substance acceptable to the City Attorney, within thirty (30) days after the consummation of the Transfer. Failure to deliver the Assumption Agreement by that date shall be a material breach of this Agreement.

9.3. Transfer Review Process. At least one hundred (120) days prior to the contemplated effective date of a sale, transfer, or assignment requiring City consent, or such longer or shorter period that the Parties agree is necessary given the circumstances of the sale,

transfer, or assignment, Licensee shall deliver to the City notice of the proposed transaction. The notice shall provide complete information on the proposed transaction, including details on the legal, financial, technical, and other qualifications of the proposed transferee. If the sale, transfer, or assignment requires consent of City, City shall acknowledge such notice within forty-five (45) days of receipt of notice. City may request additional information of Licensee that is relevant to City's review of the proposed Transfer and Licensee shall cooperate with any such request. No sale, transfer, or assignment shall be approved unless Licensee is not in default of any provision of this Agreement as of the date of the City Council's decision.

9.4. Permitted Encumbrances. Nothing in this Article shall be deemed to prohibit any assignment, pledge, lease, sublease, mortgage, or other transfer of all or any part of the Facilities or any right or interest therein, for financing purposes, provided that City's rights under this Agreement are in no way adversely affected or diminished. The consent of City shall not be required with respect to any transfer to, or taking of possession by, any banking or lending institution which is a secured creditor of Licensee of all or any part of the Fiber Network pursuant to the rights of such secured creditor under the laws of the Commonwealth of Virginia, provided further that City's rights under this Agreement are in no way adversely affected or diminished.

ARTICLE 10 REMEDIES; REMOVAL OF FACILITIES

10.1. Enforcement. Subject to applicable federal and state law and the terms and conditions of this Agreement (including any cure periods), City may apply one or a combination of the following remedies if City asserts that Licensee is in default of any provision of the License: (i) seek specific performance of any provision, which reasonably lends itself to such remedy, as an alternative to damages, or seek other equitable relief; (ii) commence an action at law for monetary damages; (iii) terminate the License in accordance with Section 10.2; or (iv) apply any other remedy provided for in this Agreement or applicable federal or state laws.

10.2. Termination Events. City, at its option, may terminate this Agreement upon any material breach of this Agreement by Licensee that is not cured within thirty (30) days after Licensee receives notice from City, or such longer period of time as may be reasonable under the circumstances, provided the cure is commenced within the thirty (30) day period after notice from City and Licensee is proceeding with reasonable diligence to complete such cure. A material breach shall include, but shall not be limited to, the following:

(a) the condemnation by public authority, other than City, or sale or dedication under threat or in lieu of condemnation, of all or substantially all of the Facilities, the effect of which would materially frustrate or impede the ability of Licensee to carry out its obligations and the purposes of this Agreement, if Licensee fails to demonstrate to the reasonable satisfaction of City, within the thirty (30) day notice period provided above, that such condemnation, sale or dedication would not materially frustrate or impede such ability of Licensee;

(b) any denial, forfeiture or revocation by any federal or state governmental authority having regulatory jurisdiction over Licensee of any authorization required by law or the expiration without renewal of any such authorization, if such events, either individually or

in the aggregate, have a material adverse effect on the installation, upgrade, construction, repair, maintenance or removal of the Facilities and Licensee has failed to take steps, within the thirty (30) day notice period provided above, to obtain or restore such authorization, and to diligently pursue such steps;

(c) an assignment for the benefit of creditors or the appointment of a receiver or trustee to take over the business of Licensee, whether in a receivership, reorganization, bankruptcy assignment for the benefit of creditors, or other action or proceeding, unless within one hundred twenty (120) days after such assignment or appointment: (1) such assignment, receivership, or trusteeship has been vacated; or (2) such assignee, receiver, or trustee has fully complied with the terms and conditions of the City Code and this Agreement and has executed an agreement, approved by a court of competent jurisdiction, under which it assumes and agrees to be bound by the terms and conditions of this Agreement and the City Code;

(d) except as may be otherwise provided in this Agreement, any failure of Licensee to maintain the insurance as required by ARTICLE 6 of this Agreement, provided Licensee has been given notice of thirty (30) days to cure such failure, or to commence a cure if a cure cannot reasonably be accomplished within such time;

(e) any failure of Licensee to maintain any form of surety required by this Agreement, provided Licensee has been given notice of thirty (30) days to cure such failure, or to commence a cure if a cure cannot reasonably be accomplished within such time;

(f) any failure of Licensee to comply with the provisions governing Transfers set forth in ARTICLE 9 of this Agreement;

(g) any abandonment of the entire Fiber Network;

(h) any persistent failure of Licensee, after notice and an opportunity to cure with respect to substantially all such failures of Licensee, to comply with any term, condition or provision of this Agreement or any ordinance, law, regulation, rule or order of City (subject in all respects to Sections 11.2 and 12.13) relating to management of the Public Rights-of-Way in connection with installation, upgrade, construction, repair, maintenance and removal of Facilities; and

(i) any other material breach by Licensee under this Agreement, provided Licensee has been given notice of thirty (30) days to cure such material breach, or to commence a cure if a cure cannot reasonably be accomplished within such time.

10.3. Removal Upon Termination or Expiration. Upon termination or expiration of the Agreement, the City shall have the right to direct Licensee to remove all or any portion of the Facilities from the Public Rights-of-Way, at Licensee's sole cost and expense. Licensee shall have the right to request that City allow Licensee to abandon all or any portion of the Facilities in place, either of Licensee's own accord or in response to a directive from the City to remove Facilities. If Licensee submits such a request, City may, in its sole discretion, allow Licensee to abandon in place all or any portion of the Facilities that were the subject of Licensee's request. If Licensee seeks authorization from City to abandon the Facilities in place, any such abandoned Facilities shall become property of City effective as of the date of City's written notice to

Licensee providing such authorization. Licensee shall remove all Facilities that are not deemed abandoned in accordance with Section 10.4.

10.4. Conditions of Removal. In the event City directs Licensee to remove any Facilities from the Public Rights-of-Way following the expiration of the Term or a notice of termination from City to Licensee, Licensee shall undertake such removal subject to the following:

(a) in removing the Facilities, or part thereof, Licensee shall refill and compact, at its own cost and expense, any excavation that shall be made by it and shall leave, in all material aspects, all Public Rights-of-Way and other property in as good condition as that prevailing prior to Licensee's removal of the Equipment from the Public Rights-of-Way and without affecting, altering or disturbing in any way any electric or other cables, wires, structures or attachments;

(b) City shall have the right to inspect and approve the condition of such Public Rights-of-Way within one hundred twenty (120) days after notice such removal is completed, and, to the extent that City determines that said Public Rights-of-Way and other property have not been left in materially as good condition as that prevailing prior to Licensee's removal of the Facilities, Licensee shall be liable to City for the cost of restoring the Public Rights-of-Way and other property to said condition;

(c) all of the surety, liability insurance and indemnity provisions of this Agreement shall remain in full force and effect during the entire period of removal and associated repair of all Public Rights-of-Way, and for not less than one hundred twenty (120) days thereafter;

(d) removal shall be commenced within sixty (60) days of the removal order by City.

10.5. Failure to Commence Removal. If Licensee has failed to commence removal of the Facilities within sixty (60) days after City has ordered their removal, then, to the extent not inconsistent with Applicable Law, City shall have the right to authorize removal by another Person of the Facilities in the Public Rights-of-Way at the Licensee's cost and expense.

10.6. Title to Facilities. To the extent consistent with Applicable Law, any portion of the Facilities designated by City for removal and not timely removed by Licensee, or permitted by City to be abandoned in place following a request by Licensee for City's consent to abandonment of Facilities, shall belong to and become the property of City without payment to Licensee, and Licensee shall execute and deliver such documents in form and substance reasonably acceptable to City, to evidence such ownership by City. Determination of whether removal of Facilities is timely shall account for other planned and/or on-going construction work in the affected Public Rights-of-Way and Licensee's ability to obtain any necessary permits from

City.

ARTICLE 11 SUBSEQUENT ACTIONS

11.1. License Approval and Terms Consistent with Applicable Law; Covenant not to Bring Certain Claims. By acceptance of the terms and conditions of this Agreement, the Parties acknowledge and agree that the processes and procedures pursuant to which this Agreement was entered into and the License was granted are consistent with Applicable Law as of the Effective Date of this Agreement. Licensee covenants and agrees that it shall not bring any suit or action or otherwise assert any claim or defense against City before any court or administrative agency asserting that any obligations of Licensee under this Agreement violate Applicable Law as of the Effective Date of this Agreement.

11.2. Procedures in Event of Subsequent Invalidity. In the event that, after the Effective Date, any court, agency, commission, legislative body, or other governmental authority of competent jurisdiction (other than City) (a) declares this Agreement invalid, in whole or in part, or (b) requires Licensee either to (i) perform any act that is inconsistent with any provision of this Agreement or (ii) cease performing any act required by any provision of this Agreement, including with respect to compensation or other financial obligations pursuant to this Agreement, then Licensee shall promptly notify City of such fact and, upon receipt of such notification, City and Licensee, acting in good faith, shall each determine whether such declaration or requirement will materially frustrate or impede the ability of Licensee to carry out its obligations pursuant to, and the purposes of, this Agreement. Regardless of City's or Licensee's determination or the length of time that such determination may take, Licensee may comply with such declaration or requirement, and such compliance will not be considered a breach or default of this Agreement. If City and Licensee, acting in good faith, agree that such declaration or requirement does not have a material and adverse effect on this Agreement, then Licensee shall continue to comply with such declaration or requirement. If either City or Licensee, acting in good faith, determines that such declaration or requirement does have such an effect or that compliance with such declaration or requirement by Licensee would materially frustrate or impede the ability of Licensee to carry out its obligations pursuant to, and the purposes of, this Agreement, then Licensee and City shall enter into good faith negotiations to amend this Agreement. If the Licensee or the City fails to negotiate in good faith to produce an agreement which is reasonably acceptable to both the City and the Licensee, then the Licensee or the City may accelerate the expiration of the Term so that the Term shall expire on a date determined by the party accelerating the Term not less than six (6) months after such determination. In the event there are six (6) months or less remaining in the Term, this Section 11.2 shall not operate to extend the Term.

ARTICLE 12 MISCELLANEOUS

12.1. Force Majeure. Notwithstanding any other provision of this Agreement, Licensee shall not be liable for delay in performance of, or failure to perform, in whole or in part, its obligations pursuant to this Agreement provided that such delay or failure shall not be attributable to events that are not within the reasonable control of, nor the result of the negligence

of, Licensee, and which, by the exercise of commercially reasonable efforts, Licensee is unable to overcome or avoid or cause to be avoided, including but not limited to acts of God, fire, explosion, flood, storm or other similar catastrophe, war, revolution, civil commotion, labor strikes, labor or materials shortages affecting the communications industry as a whole, delays by government (or any department, agency, commission, court, or bureau of government) in providing authorization necessary for Licensee to complete performance under this Agreement, acts of public enemies, pandemic, terrorism, or national emergency, or any law, order, or regulation of the government (or any department, agency, commission, court, or bureau of a government) resulting from the above. If such delay in performance or failure to perform affects only part of Licensee's capacity to perform, Licensee shall perform to the maximum extent it is able to do so and shall take all reasonable steps within its power to correct such cause(s). Licensee agrees that in correcting such cause(s), it shall take all reasonable steps to do so in as expeditious a manner as possible.

12.2. Notices. Any notice provided for under this Agreement shall be effective if in writing and: (a) delivered personally to the addressee or deposited in the United States mail, postage prepaid, certified mail, return receipt requested; or (b) sent by overnight or commercial air courier. Notice will be deemed to have been adequately given three (3) days following the date of mailing, or immediately if personally served. In addition to the foregoing, copies of notices to the City shall be delivered by electronic mail. Notices shall be addressed as follows, or to such other address as the receiving party specifies in writing:

If to City:

Alexandria City Hall
301 King Street
Alexandria, VA 22314
Attention: City Manager
Electronic mail: James.Parajon@alexandria.va.gov

With a copy to:

Alexandria City Hall
301 King Street
Alexandria, VA 22314
Attention: City Attorney
Electronic mail: Joanna.Anderson@alexandria.va.gov

If to Licensee:

Crown Castle Fiber LLC
2000 Corporate Drive
Canonsburg, PA 15317
Attention: Network Contracts Management

With a copy to:

Crown Castle Fiber LLC
2000 Corporate Drive
Canonsburg, PA 15317
Attention: Ken Simon, General Counsel

12.3. Additional Representations and Warranties. In addition to the representations, warranties, and covenants of Licensee to City set forth elsewhere in this Agreement, Licensee represents and warrants to City (which representations and warranties shall not be affected or waived by any inspection or examination made by or on behalf of City) that, as of the Effective Date:

(a) **Organization, Standing, Power, Authorization and Enforceability.** Licensee is organized in the State of New York, is duly organized, validly existing and in good standing under the laws of the Commonwealth of Virginia and is duly authorized to do business in the Commonwealth of Virginia and the City of Alexandria. Licensee has all requisite power and authority to execute, deliver and perform this Agreement and all other agreements entered into or delivered in connection with or as contemplated hereby. Licensee also has all requisite power and authority to own or lease its properties and assets and to conduct its businesses as currently conducted except as would not have an adverse effect on Licensee's performance of its obligations under this Agreement or restrict or limit Licensee from taking any action required of Licensee by this Agreement.

(b) The execution, delivery and performance of this Agreement and all other agreements entered into in connection with the transactions contemplated hereby have been duly, legally and validly authorized by all necessary action on the part of Licensee, and this Agreement and all other agreements entered into in connection with the transactions contemplated hereby have been duly executed and delivered by Licensee and constitute (or upon execution and delivery will constitute) the valid and binding obligations of Licensee.

(c) **Consent.** No consent, approval or authorization of, or declaration or filing with any public, governmental or other authority (including without limitation, the FCC or any other federal agency or any state, country, or municipal agency, authority, commission or council and, if applicable public utility commissions) on the part of Licensee is required for the valid execution and delivery of this Agreement or any other agreement or instrument executed or delivered in connection herewith.

(d) **No Coercion; Full Disclosure.** Licensee enters into this Agreement willingly and without coercion, undue influence or duress. In addition, Licensee has not entered into this Agreement with the intent to act contrary to the provisions herein.

(e) **Compliance with Law.** Licensee is in material compliance with all laws, ordinances, decrees and governmental rules and regulations applicable to the installation, upgrade, construction, repair, maintenance, and removal of the Fiber Network in the City of Alexandria.

(f) **Litigation: Investigations.** Except as disclosed in writing to City prior to the execution of this Agreement, there is no civil, criminal, administrative, arbitration or other proceeding, investigation or claim, pending or threatened against Licensee, at law or in equity, or before any foreign, federal, state, municipal or other governmental department, commission, board, bureau, agency or instrumentality, including, without limitation, matters involving the granting of a temporary or permanent injunction against Licensee that, if granted would have a material effect on the ability of Licensee to comply with this Agreement or to take any action to be taken by Licensee pursuant to this Agreement.

12.4. Additional Covenants. Until the termination of this Agreement and the satisfaction in full by Licensee of its obligations under this Agreement, in consideration of the License, Licensee agrees that it will comply with the following affirmative covenants, unless City otherwise consents in writing:

(a) **Compliance with Laws; Licenses and Permits.** Licensee shall comply with: (i) all applicable federal and state laws, rules, regulations, orders, writs, decrees and judgments relating to the installation, upgrade, construction, repair, maintenance and removal of the Facilities and (ii) all local laws and all reasonable rules, regulations, orders, or other directives of City issued pursuant to this Agreement relating to the installation, upgrade, construction, repair, maintenance and removal of Facilities. Licensee shall have the sole responsibility for obtaining all permits, licenses and other forms of approval or authorization necessary to install upgrade, construct, repair, maintain and remove Facilities.

(b) **Ability to Perform.** In the event City reasonably identifies a material risk that Licensee will be unable to perform its material obligations under this Agreement, including the installation, upgrade, construction, repair, maintenance and removal of the Facilities, City may request in writing, and Licensee shall provide to City, a report addressing such matters and containing such detail and substance to reasonably demonstrate that it can perform on a timely basis, all material obligations pursuant to this Agreement. Licensee shall supplement any such report as the City may reasonably request.

(c) **Condition of Facilities.** All Facilities will be maintained in good repair and condition throughout the Term, to the extent necessary to avoid damaging the Public Rights-of-Way.

12.5. Survival. All representations and warranties contained in this Agreement shall survive the Term. Licensee acknowledges that certain of the obligations to be performed under this Agreement are to be performed after the License terminates or expires.

12.6. Binding Effect. This Agreement shall be binding upon and inure to the benefit of City and Licensee and their respective successors and permitted transferees and assigns.

12.7. Headings; Other Terms. The headings contained in this Agreement are to facilitate reference only, do not form a part of this Agreement, and shall not in any way affect the construction or interpretation hereof. Terms such as “hereby”, “herein”, “hereof”, “hereinafter”, “hereunder”, and “hereto” refer to this Agreement as a whole and not to the particular sentence or paragraph where they appear, unless the context otherwise requires. The

term “may” is permissive; the terms “shall” and “will” are mandatory, not merely directive. All references to any gender shall be deemed to include all others, as the context may require. Terms used in the plural include the singular, and vice versa, unless the context otherwise requires.

12.8. Interference with Contracts; Third-Party Beneficiary Rights. Nothing in this License is intended to interfere with any contracts or other arrangements between Licensee and a third party. Nothing in this License is intended to create any third-party beneficiary rights.

12.9. Entire Agreement. This Agreement embodies the entire understanding and agreement of City and Licensee with respect to the subject matter hereof and merges and supersedes all prior representations, agreements and understandings, whether oral or written, between City and Licensee with respect to the subject matter hereof, including, without limitation, all prior drafts of this Agreement and any and all written or oral statements or representations by any official, employee, agent, attorney, consultant or independent contractor of City or Licensee.

12.10. No Waiver; Cumulative Remedies. No failure on the part of City or Licensee to exercise, and no delay in exercising, any right hereunder shall operate as a waiver thereof, nor shall any single or partial exercise of any such right preclude any other right, all subject to the conditions and limitations established in this Agreement. The rights and remedies provided herein are cumulative and not exclusive of any remedies provided by law, and nothing contained in this Agreement shall impair any of the rights of City or Licensee under Applicable Law, subject in each case to the terms and conditions of this Agreement. A waiver of any right or remedy by City or Licensee at any one time shall not affect the exercise of such right or remedy or any other right or other remedy by City or Licensee at any other time. In order for any waiver of City or Licensee to be effective, it must be in writing.

12.11. Delegation of City Rights. City reserves the right to delegate and redelegate, from time to time, any of its rights or obligations under this Agreement to any body, organization or official of City. Upon any such delegation or redelegation, references to “City” in this Agreement shall refer to the body, organization or official to whom such delegation or redelegation has been made. Any such delegation by City shall be effective upon written notice by City to Licensee of such delegation. Upon receipt of such notice by Licensee, Licensee shall be bound by all terms and conditions of the delegation not in conflict with this Agreement. Any such delegation, revocation or redelegation, no matter how often made, shall not be deemed an amendment to this Agreement or require any consent of Licensee.

12.12. Claims Under Agreement. City and Licensee agree that any and all claims asserted by or against City arising under this Agreement or related thereto shall be heard and determined either in a court of the United States located in the City of Alexandria or in any court of the Commonwealth of Virginia located in the City of Alexandria.

12.13. Reservation of Rights. City reserves the right to adopt or issue such rules, regulations, orders or other directives governing Licensee and the Facilities as it shall find necessary, appropriate and within the exercise of its police power or such other power or authority as City may have, and such other orders as City shall find necessary or appropriate relating to management of the Public Rights-of-Way, and Licensee expressly agrees to comply

with all such lawful rules, regulations, orders or other directives, provided that such rules, regulations, orders or other directives are of general applicability. No rule, regulation, order or other directive issued pursuant to this Section 12.13 shall constitute an amendment to this Agreement, provided that such rule, regulation, order or other directive is not inconsistent with this Agreement. The parties agree to undertake discussions toward achieving mutually acceptable solutions to issues identified by either party and related to this License.

[signature page follows]

FINAL

IN WITNESS WHEREOF the parties hereto have caused this Agreement to be executed by duly authorized representatives of the parties on the dates written below.

CITY:

THE CITY OF ALEXANDRIA, VIRGINIA, a
municipal corporation of Virginia

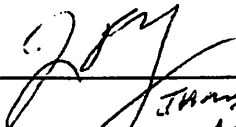
By:  James F. Parajon, City Manager
Name: James Parajon
Title: CM
Date: 10/25/22

APPROVED AS TO FORM:

By: Karen Snow
Senior Assistant City Attorney

LICENSEE:

CROWN CASTLE FIBER LLC

By: 
Name: Erin M Francis
Title: Supervisor Contract Management
Date: 10/18/22

FINAL

EXHIBIT A

UNDERGROUND CONSTRUCTION SPECIFICATIONS

[Attached]

MICROTRENCH TYPICALS WITH OFFSET

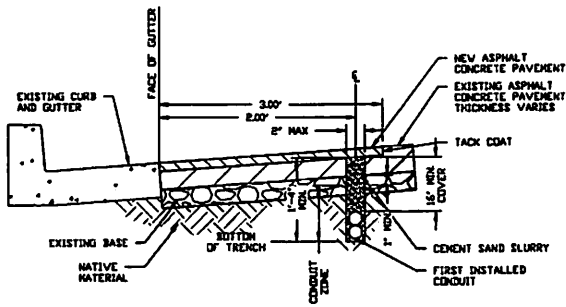

TYPICAL MICROTRENCH SECTION
(INTEGRAL CURB AND GUTTER SHOWN)

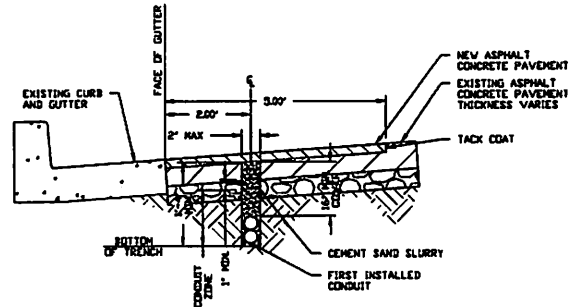

TYPICAL MICROTRENCH SECTION W/ BIKE LANE
(INTEGRAL CURB AND GUTTER SHOWN)

HDPE CONDUIT CONFIGURATION

1. THE BOTTOM OF THE TRENCH SHALL BE LEVEL, FLAT AND NOT HAVE ANY ROCK DEBRIS.
2. ALL BACKFILL MUST BE APPROVED BY ENGINEER, AND/OR PERMITTING AUTHORITY INSPECTOR.
3. EXCAVATED MATERIAL MAY BE DEEMED SUITABLE BACKFILL BY ENGINEER AND/OR PERMITTING AUTHORITY INSPECTOR.
4. MINIMUM SIX (6) INCHES OF CLEAN SAND SHALL BE PLACED OVER THE CONDUIT.
5. FLOWABLE FILL MIX DESIGN SHALL BE PER CITY AND/OR PERMITTING AUTHORITY.
6. ALL FLOWABLE FILL AND CONCRETE SHALL BE VIBRATED USING A 2" DIAMETER VIBRATOR.
7. CONCRETE AND ASPHALT THICKNESS SHALL MATCH EXISTING.
8. 84 CONDUITS SHOULD BE DRILLED INTO ADJACENT UNDISTURBED CONCRETE TO PREVENT DIFFERENTIAL SETTLEMENT.

RESTORATION NOTES

1. THE BOTTOM OF THE TRENCH SHALL BE LEVEL, FLAT AND NOT HAVE ANY ROCK DEBRIS.
2. ALL BACKFILL MUST BE APPROVED BY ENGINEER, AND/OR PERMITTING AUTHORITY INSPECTOR.
3. HOOD TRENCH REQUIRES ADDITIONAL BACKFILL MEDIA SUCH AS HOT POLYMER, ELASTO POLYESTER OR GROUT TO RESTORE SURFACE.
4. FLOWABLE FILL MIX DESIGN SHALL BE PER CITY AND/OR PERMITTING AUTHORITY.
5. TRAVEL LANES, OFFSET PAST 2" REQUIRES FULL LANE MILL AND PAVE. ROAD CROSSING REQUIRES 8'-0" FULL LANE MILL AND PAVE.
6. FINAL RESTORATION WILL BE SUBJECT TO PREVAILING PUBLISHED CITY OF ALEXANDRIA STANDARDS.



**ALEXANDRIA, VIRGINIA
MICROTRENCH TYPICAL
WITH OFFSET**

NOT FOR OUTSIDE DISCLOSURE
WITHOUT EXPLICIT PERMISSION
FROM CROWN CASTLE

| | | |
|--------------|-----------------------|-----------------------|
| FILE: 17354 | ENGINEER: C. GOODRICH | DRAFTER: V. DICKERSON |
| REVISION: 04 | DATE: 09/12/22 | SHEET: 101 OF 107 |

RESTORATION DETAIL FOR TEST PITTING

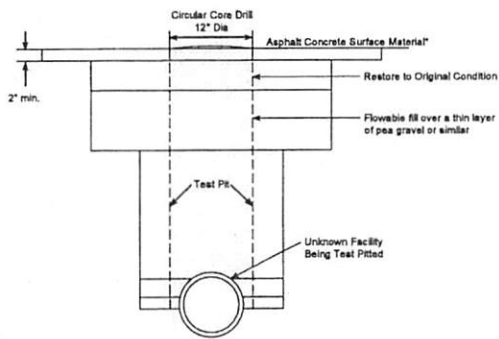

ASPHALT RESTORATION TEST PIT DETAIL
CIRCULAR TEST PIT

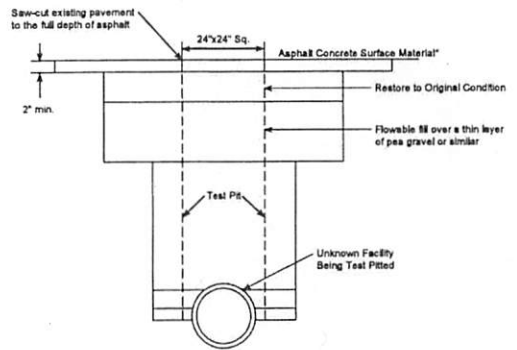
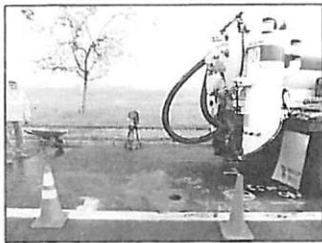

ASPHALT RESTORATION TEST PIT DETAIL
SQUARE TEST PIT



NOTES:

ASPHALT CONCRETE SURFACE MATERIAL:
SM-9.5A FOR ADT < 10,000
SM-9.5D FOR ADT > 10,000

THE DISTRICT ADMINISTRATOR'S DESIGNEE SHALL DETERMINE THE RESTORATION REQUIREMENTS FOR OTHER PAVEMENT TYPES

TRENCH WIDTH AND PIPE BEDDING SHALL BE IN ACCORDANCE WITH VDOT STD. PB-1

12 INCHES MINIMUM BEYOND THE EDGE OF THE TRENCH ON LONGITUDINAL OPEN CUTS, OR 25 FEET MINIMUM BEYOND THE TRENCH CENTERLINE ON PERPENDICULAR OPEN CUTS, OR AS DETERMINED BY THE DISTRICT ADMINISTRATOR'S DESIGNEE.



**ALEXANDRIA, VIRGINIA
MICROTRENCH TYPICAL
WITH OFFSET**

NOT FOR OUTSIDE DISCLOSURE
WITHOUT EXPLICIT PERMISSION
FROM CROWN CASTLE.

| | | |
|--------------|-----------------------|-----------------------|
| FILE: 17354 | ENGINEER: C. GOODRICH | DRAFTER: V. DICKERSON |
| REVISION: 04 | DATE: 09/12/22 | SHEET: T02 OF T07 |

TYPICAL 2'x3'x2' HANDHOLE DETAIL

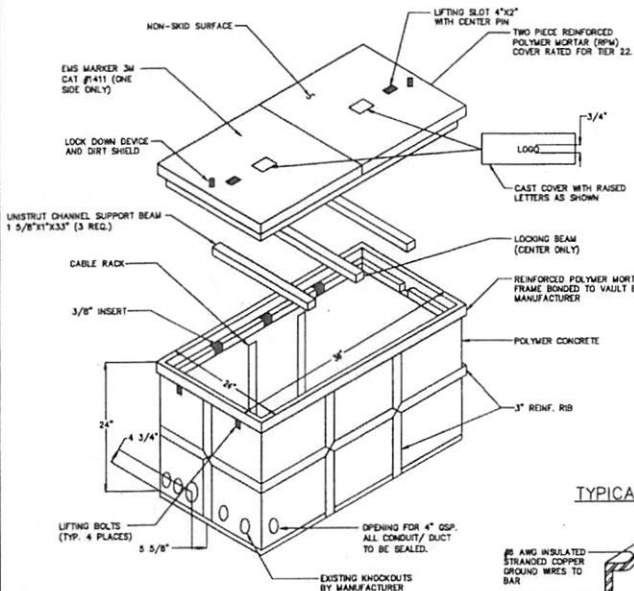

CONDUIT PLUG TYPICAL (NOT TO SCALE)

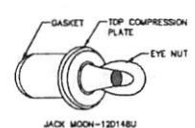

PVC CORE TYPICAL

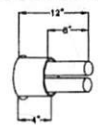

TYPICAL HANDHOLE WITH SPLICE COIL

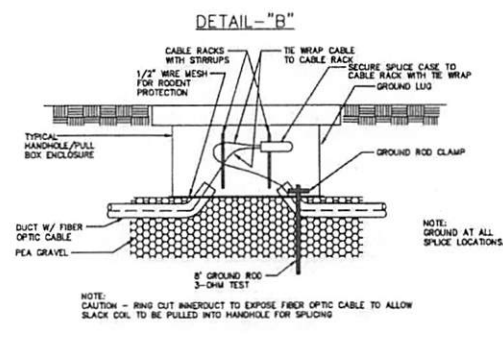
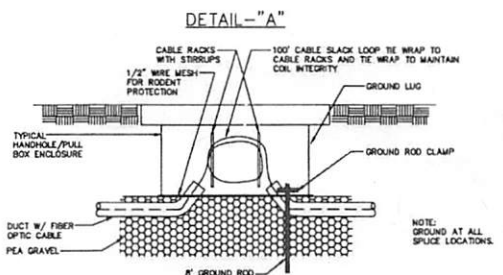
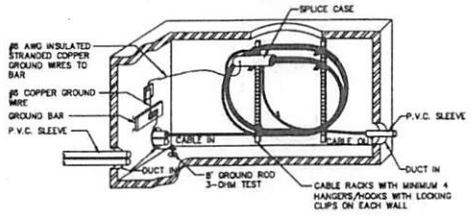

RESTORATION NOTES

1. FINAL RESTORATION WILL BE SUBJECT TO PREVAILING PUBLISHED CITY OF ALEXANDRIA STANDARD(S).

NOTES:

- THE HANDHOLE SHALL BE SET WITH THE TOP COVER LEVELLED AND MATCHING THE EXISTING SURFACE.
- THE FLOOR OF THE PIT SHALL BE COVERED WITH 10"-12" OF PEA GRAVEL IN WATER PRONE AREAS 18" OF GRAVEL SHALL BE USED TO IMPROVE DRAINAGE. THE BASE OF THE HANDHOLE/PULL BOX SHALL BE OPEN, AND PLACED IN THE CENTER OF THE PIT.
- AN 8" LG. X 3/8" DIA. COPPER CLAD GROUND ROD SHALL BE DRIVEN INTO THE BOTTOM OF THE HANDHOLE/PULL BOX. A 3-OHM TEST IS REQUIRED. (SEE DETAIL A). A BARE 6" LG. #6 COPPER GROUND WIRE SHALL BE CLAMPED TO THE ROD AND ATTACHED TO THE GROUND LUG ON THE SIDE WALL OF THE HANDHOLE.
- THE DUCT PLACED INTO HANDHOLE WALLS WILL USE APPROVED DUCT TERMINATORS TO SEAL DUCT ENTRANCE.
- THE ANNULAR SPACE BETWEEN THE DUCT WALL AND THE FIBER OPTIC CABLE SHALL BE SEALED USING A SPLIT PLUG. THE SPLIT PLUG SHALL BE SIZED ACCORDING TO THE OUTSIDE DIAMETER OF THE FIBER OPTIC CABLE AND THE INSIDE DIAMETER OF THE DUCT.
- ALL VACANT DUCTS SHALL BE SEALED USING AN EXPANDABLE BLANK DUCT PLUG. THE DUCT PLUG SHALL BE SIZED ACCORDING TO THE INSIDE DIAMETER OF THE DUCT.
- THE DESIGN LOADING FOR HANDHOLE IN GRASS SHALL BE CAPABLE OF SUPPORTING H-22 LOADING PER THE AMERICAN ASSOCIATION OF STATE HIGHWAY AND TRANSPORTATION OFFICIALS (AASHTO) OR EQUIVALENT A-12 LOADING PER AMERICAN SOCIETY FOR TESTING AND MATERIALS (ASTM) OR EQUIVALENT TIER 22 LOADING AS DEFINED BY AASHTO/77-2007. HANDHOLES IN ROADWAY OR SHARED USE PATHS TO BE CAPABLE OF SUPPORTING H-20 LOADING AND LIDS TO BE ADA COMPLIANT.

| | | |
|--|-----------------------|---|
| CROWN CASTLE | | NOT FOR OUTSIDE DISCLOSURE WITHOUT EXPLICIT PERMISSION FROM CROWN CASTLE. |
| ALEXANDRIA, VIRGINIA MICROTRENCH TYPICAL WITH OFFSET | | |
| FILE: 17354 | ENGINEER: C. GOODRICH | DRAFTER: V. DICKERSON |
| REVISION: 04 | DATE: 09/12/22 | SHEET: T04 OF T07 |

TYPICAL 3'x3'x3' MANHOLE DETAIL

TYPICAL DETAIL "A"

TYPICAL RECK EXTENSION DETAIL

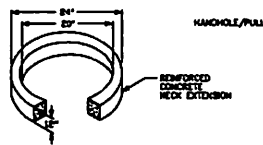

TYPICAL DETAIL "D"

DALNORTH QUICKSET MANHOLE
WALLS 6" HEADROOM 6" MIN.

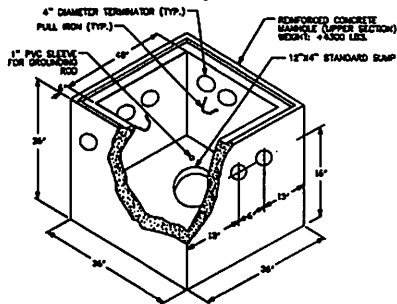
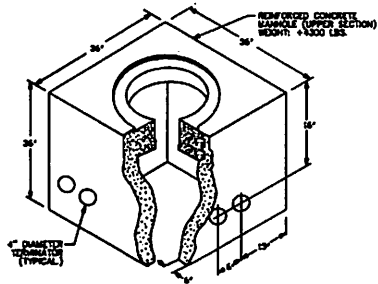

TYPICAL DETAIL "B"

MANHOLE COVER DIMENSIONS (B-J)

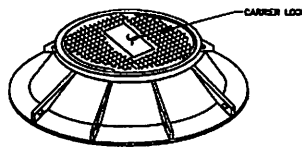

- NOTES**
1. EACH COVER TO HAVE (4) PICK SLITS FOR REINFORCING
 2. STAMP CARBONITE 13 IN COVER
 3. ACCESS HOLE 3"

TYPICAL DETAIL "E"

RING AND COVER DETAIL
RING 300mm COVER 300mm

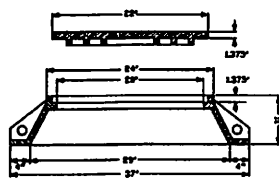

TYPICAL DETAIL "G"

TYPICAL MANHOLE EXCAVATION PIT

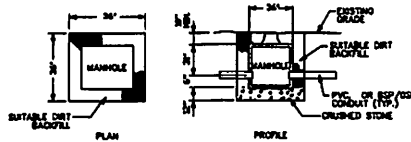

TYPICAL DETAIL "C"

TERMINATORS, RAMP, & GROUND ROD SLEEVE
2 SECTIONS

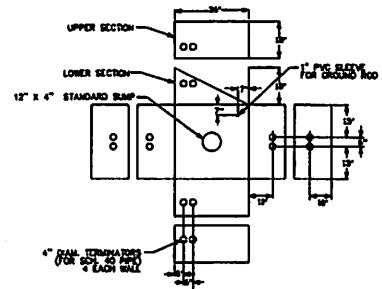

TYPICAL DETAIL "F"

BOLT INSERTS AND PULL IRONS
2 SECTIONS

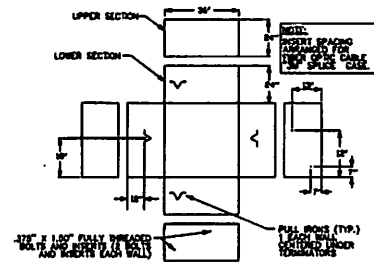

NOTES:
VOID IN EXCAVATED AREAS TO BE BACKFILLED WITH SELECT MATERIAL.
BOTTOM OF EXCAVATED PIT TO BE BACKFILLED WITH 12" OF CRUSHED STONE (3/4" GRADE).
SHORING WILL BE REQUIRED.
ALL MANHOLES SHALL BE PLACED WITH COVER FLUSH WITH EXISTING GRADE.

RESTORATION NOTES

1. FINAL RESTORATION WILL BE SUBJECT TO PREVAILING PUBLISHED CITY OF ALEXANDRIA STANDARDS.



**ALEXANDRIA, VIRGINIA
MICROTRENCH TYPICAL
WITH OFFSET**

NOT FOR OUTSIDE DISCLOSURE
WITHOUT EXPRESS PERMISSION
FROM CROWN CASTLE

| | | |
|--------------|-----------------------|-----------------------|
| FILE: 17354 | ENGINEER: C. GOODRICH | DRAFTER: V. DICKERSON |
| REVISION: 04 | DATE: 09/12/22 | SHEET: 105 OF 107 |

UTILITY CROSSING TYPICAL

ELECTRIC CROSSING
SCALE: NTS

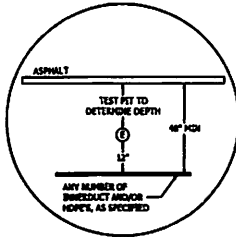

GAS CROSSING
SCALE: NTS

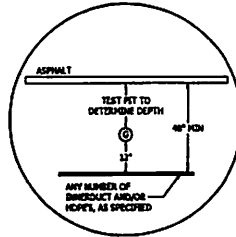

SEWER CROSSING
SCALE: NTS

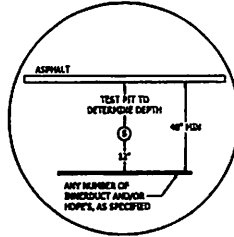

STORM DRAIN CROSSING (ASPHALT)
SCALE: NTS

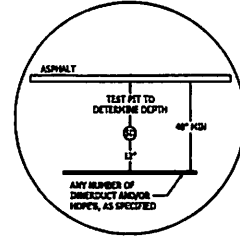

TELEPHONE CROSSING
SCALE: NTS

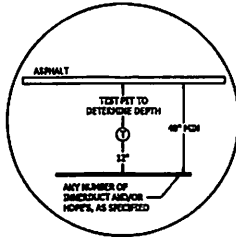

TRAFFIC CROSSING
SCALE: NTS

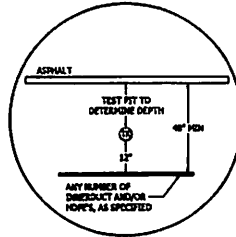

WATER CROSSING
SCALE: NTS

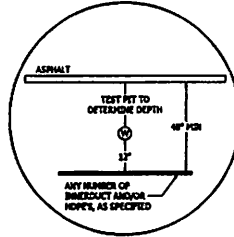

UTILITY CROSSING (GRASS)
SCALE: NTS

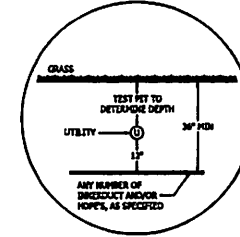

ALEXANDRIA, VIRGINIA
MICROTRENCH TYPICAL
WITH OFFSET

NOT FOR OUTSIDE DISCLOSURE
WITHOUT EXPRESS PERMISSION
FROM CROWN CASTLE

| | | |
|--------------|-----------------------|-----------------------|
| FILE: 17354 | ENGINEER: C. GOODRICH | DRAFTER: V. DICKERSON |
| REVISION: 04 | DATE: 09/12/22 | SHEET: T06 OF T07 |

MICROTRENCH PLAN VIEW

DEFAULT 24" OFFSET MICROTRENCH PROFILE - FRONT OF CURB

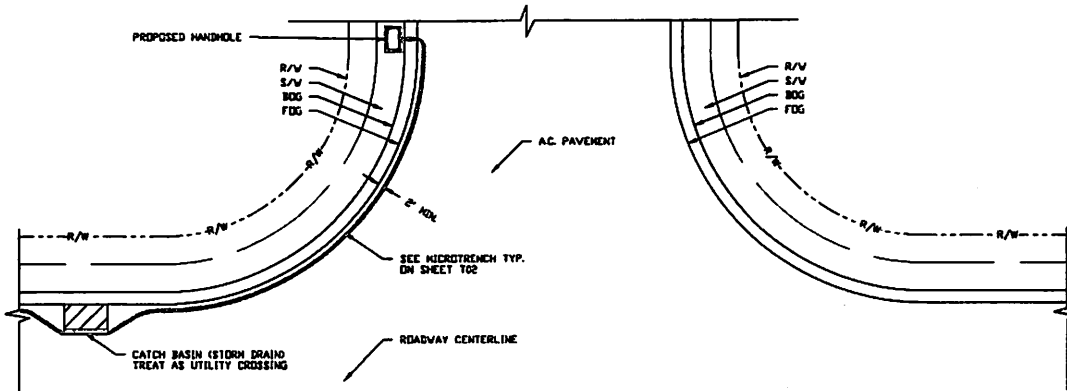

PLAN VIEW
SCALE: N.T.S.

RESTORATION NOTES

1. THE BOTTOM OF THE TRENCH SHALL BE LEVEL, FLAT AND NOT HAVE ANY ROCK DEBRIS.
2. ALL BACKFILL MUST BE APPROVED BY ENGINEER, AND/OR PERMITTING AUTHORITY INSPECTOR.
3. MICRO TRENCH REQUIRES ADDITIONAL BACKFILL MEDIA, SUCH AS HOT POLYMER, ELASTO POLYESTER OR GROUT TO RESTORE SURFACE.
4. FLOWABLE FILL MIX DESIGN SHALL BE PER CITY AND/OR PERMITTING AUTHORITY.
5. TUNNEL UNDER CURB & GUTTER. THERE SHALL BE NO DAMAGE TO THE CURB.
6. FINAL RESTORATION WILL BE SUBJECT TO PREVAILING PUBLISHED CITY OF ALEXANDRIA STANDARDS.

| | | |
|--|-----------------------|--|
| CROWN CASTLE | | NOT FOR OUTSIDE DISCLOSURE WITHOUT EXPLICIT PERMISSION FROM CROWN CASTLE |
| ALEXANDRIA, VIRGINIA MICROTRENCH TYPICAL WITH OFFSET | | |
| FILE: 17354 | ENGINEER: C. GOODRICH | DRAFTER: V. DICKERSON |
| REVISION: 04 | DATE: 09/12/22 | SHEET: T07 OF T07 |

FINAL

EXHIBIT B
INITIAL CONSTRUCTION PLAN

[Attached]



City of Alexandria

Franchise – Propose Construction Zones and Method

9/12 /2022

The pathway to possible.

AGENCY CUSTOMER ID: _____

LOC #: _____



ADDITIONAL REMARKS SCHEDULE

Page 2 of 2

| | | | |
|--|-------------------------|--|--|
| AGENCY Willis Towers Watson Northeast, Inc. | | NAMED INSURED Crown Castle Inc. f/k/a Crown Castle International Corp. See Attached Named Insured List | |
| POLICY NUMBER See Page 1 | | 8020 Katy Freeway Houston, TX 77024 | |
| CARRIER See Page 1 | NAIC CODE See Page 1 | EFFECTIVE DATE: See Page 1 | |

ADDITIONAL REMARKS

THIS ADDITIONAL REMARKS FORM IS A SCHEDULE TO ACORD FORM,

FORM NUMBER: 25 FORM TITLE: Certificate of Liability Insurance

as their interest may appear with respect to the Automobile Liability for liability arising out of the operations or work performed by the named insured, if required by written agreement.

ALEXANDRIA – Proposed Micro Trenching & Bore Construction

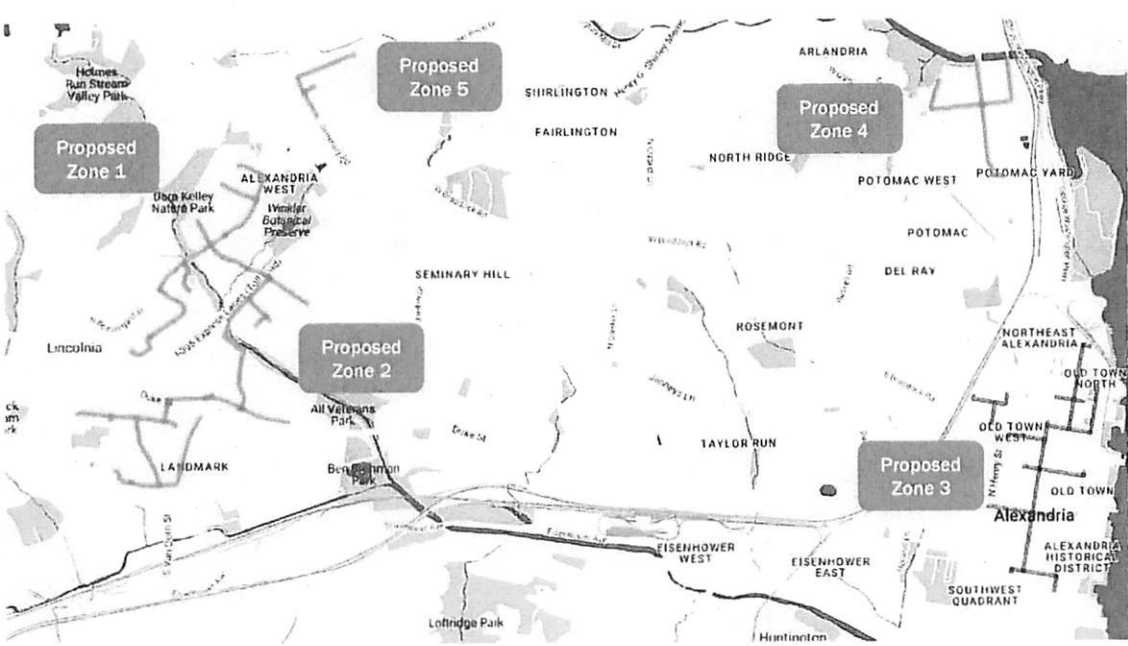

| Proposed Construction | |
|-----------------------------|-----------|
| Total Zones | 5 |
| Proposed Bore (Red) | 8.4 miles |
| Micro Trenching (Black) | 3.6 Miles |
| Proposed Total Construction | 12 miles |



Zone 1 – (Hub 7WAC184A)

| Proposed Construction | |
|-----------------------------|-----------|
| Proposed Bore (Red) | 2.4 miles |
| Proposed Total Construction | 2.4 miles |

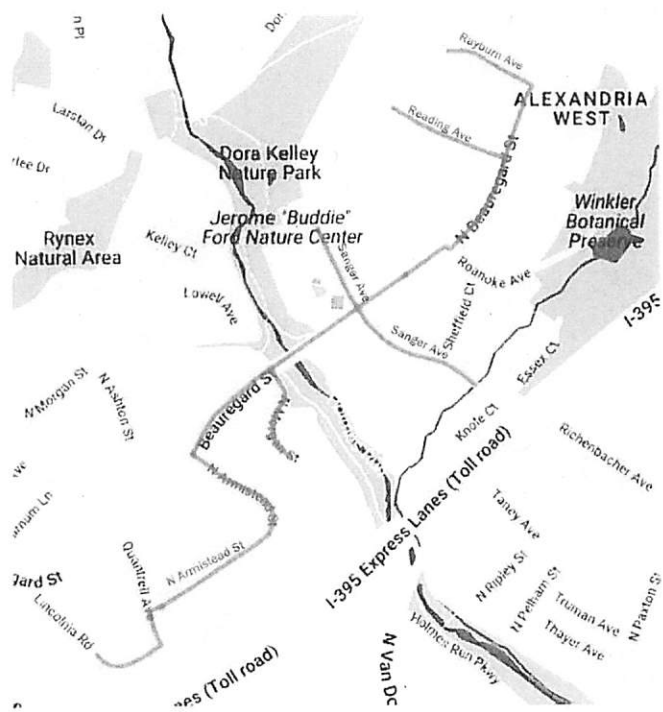

Zone 2 - Hub 7WAC223B

| Proposed Construction | |
|-----------------------------|-----------|
| Proposed Bore (Red) | 3.9 miles |
| Proposed Total Construction | 3.9 miles |

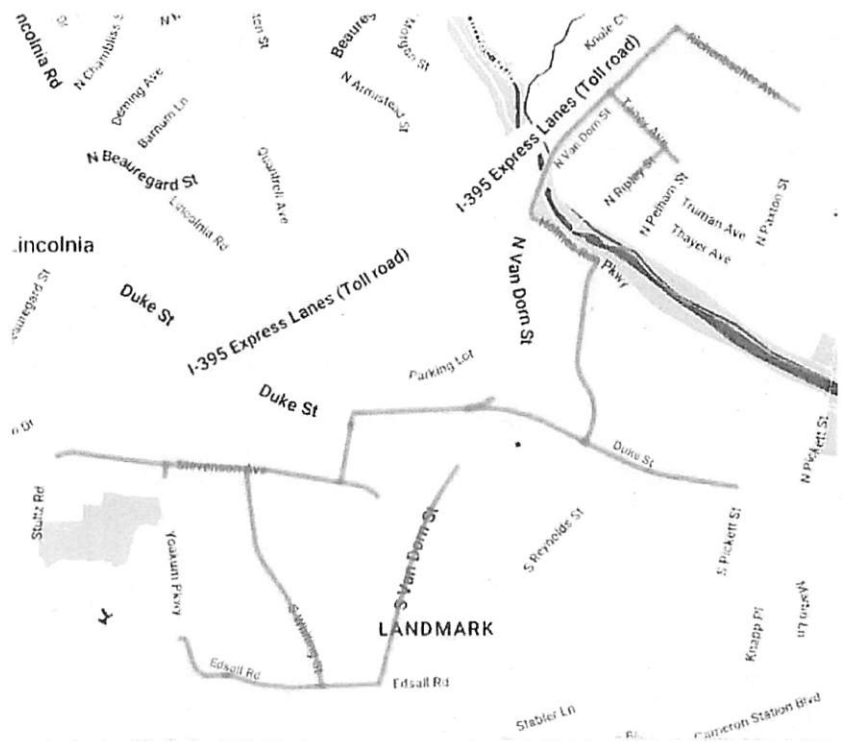

| Proposed Construction | |
|-----------------------------|-----------|
| Micro Trenching (Black) | 3.2 Miles |
| Proposed Total Construction | 3.2 Miles |

Zone 3 - Hub 7WAC014A

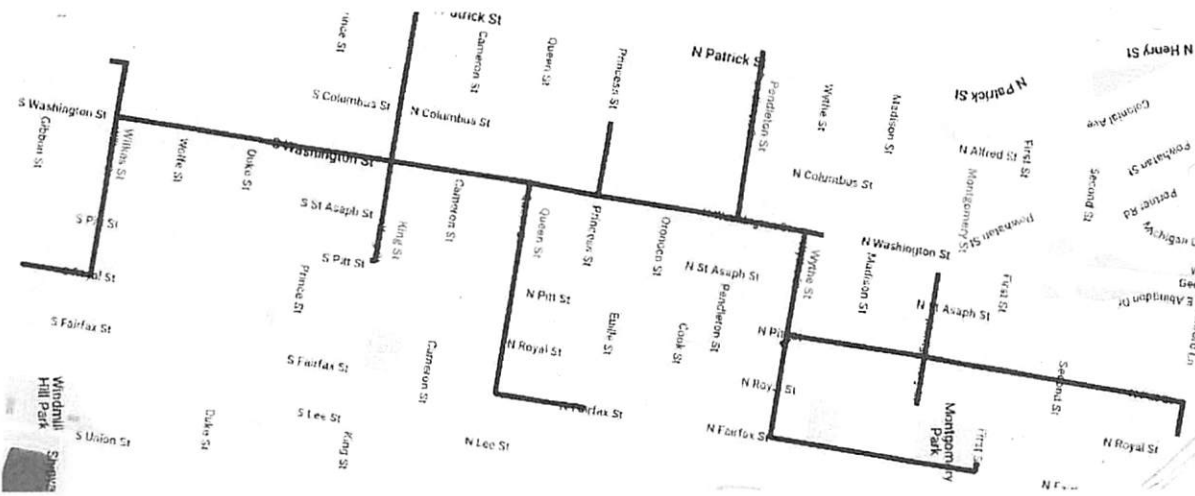

Zone 3- Hub 7WAC260B

| Proposed Construction | |
|-----------------------------|-----------|
| Micro Trenching (Black) | 0.4 Miles |
| Proposed Total Construction | 0.4 miles |



Zone 4- Hub 7WAC400A

| Proposed Construction | |
|-----------------------------|-----------|
| Proposed Bore (Red) | 1.5 miles |
| Proposed Total Construction | 1.5 miles |

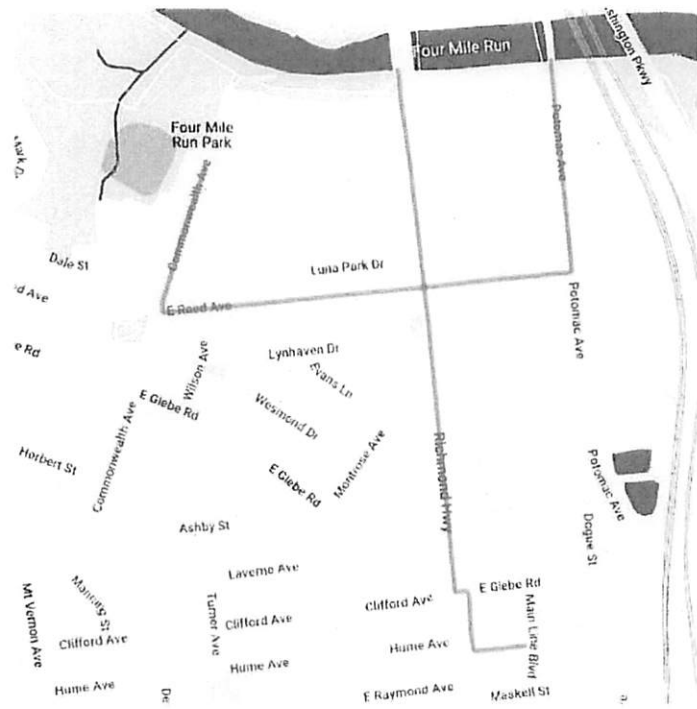

Zone 5 - Hub 7WAC171D

| Proposed Construction | |
|-----------------------------|-----------|
| Proposed Bore (Red) | 0.6 miles |
| Proposed Total Construction | 0.6 miles |

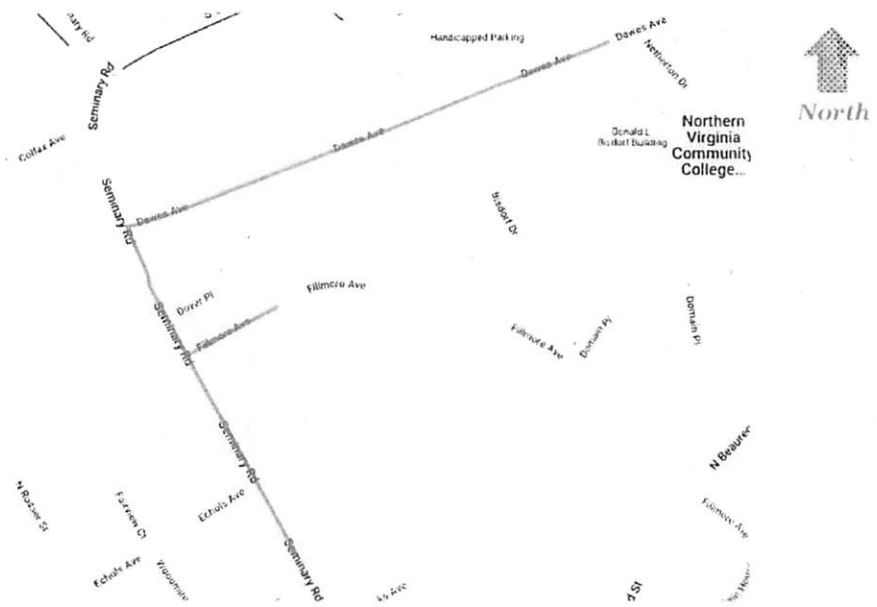



CERTIFICATE OF LIABILITY INSURANCE

DATE (MM/DD/YYYY)
10/18/2022

THIS CERTIFICATE IS ISSUED AS A MATTER OF INFORMATION ONLY AND CONFERS NO RIGHTS UPON THE CERTIFICATE HOLDER. THIS CERTIFICATE DOES NOT AFFIRMATIVELY OR NEGATIVELY AMEND, EXTEND OR ALTER THE COVERAGE AFFORDED BY THE POLICIES BELOW. THIS CERTIFICATE OF INSURANCE DOES NOT CONSTITUTE A CONTRACT BETWEEN THE ISSUING INSURER(S), AUTHORIZED REPRESENTATIVE OR PRODUCER, AND THE CERTIFICATE HOLDER.

IMPORTANT: If the certificate holder is an ADDITIONAL INSURED, the policy(ies) must have ADDITIONAL INSURED provisions or be endorsed. If SUBROGATION IS WAIVED, subject to the terms and conditions of the policy, certain policies may require an endorsement. A statement on this certificate does not confer rights to the certificate holder in lieu of such endorsement(s).

| | | |
|---|---|--|
| PRODUCER Willis Towers Watson Northeast, Inc. c/o 26 Century Blvd P.O. Box 305191 Nashville, TN 372305191 USA | CONTACT NAME: Crown Castle International PHONE (A/C, No, Ext): FAX (A/C, No): E-MAIL ADDRESS: COIRequest@crowncastle.com | |
| | INSURER(S) AFFORDING COVERAGE | |
| INSURED Crown Castle Inc. f/k/a Crown Castle International Corp. See Attached Named Insured List 8020 Katy Freeway Houston, TX 77024 | INSURER A: Continental Casualty Company NAIC # 20443 | |
| | INSURER B: Berkshire Hathaway Specialty Insurance Com 22276 | |
| | INSURER C: Continental Insurance Company 35289 | |
| | INSURER D: | |
| | INSURER E: | |
| INSURER F: | | |

COVERAGES **CERTIFICATE NUMBER: W26324289** **REVISION NUMBER:**

THIS IS TO CERTIFY THAT THE POLICIES OF INSURANCE LISTED BELOW HAVE BEEN ISSUED TO THE INSURED NAMED ABOVE FOR THE POLICY PERIOD INDICATED. NOTWITHSTANDING ANY REQUIREMENT, TERM OR CONDITION OF ANY CONTRACT OR OTHER DOCUMENT WITH RESPECT TO WHICH THIS CERTIFICATE MAY BE ISSUED OR MAY PERTAIN, THE INSURANCE AFFORDED BY THE POLICIES DESCRIBED HEREIN IS SUBJECT TO ALL THE TERMS, EXCLUSIONS AND CONDITIONS OF SUCH POLICIES. LIMITS SHOWN MAY HAVE BEEN REDUCED BY PAID CLAIMS.

| INSR LTR | TYPE OF INSURANCE | ADDL INSD | SUBR WVD | POLICY NUMBER | POLICY EFF (MM/DD/YYYY) | POLICY EXP (MM/DD/YYYY) | LIMITS | |
|----------|---|-----------|----------|------------------|-------------------------|-------------------------|--|--|
| A | <input checked="" type="checkbox"/> COMMERCIAL GENERAL LIABILITY <input type="checkbox"/> CLAIMS-MADE <input checked="" type="checkbox"/> OCCUR GEN'L AGGREGATE LIMIT APPLIES PER: <input checked="" type="checkbox"/> POLICY <input type="checkbox"/> PRO-JECT <input type="checkbox"/> LOC OTHER: | | Y | 7018331477 | 04/01/2022 | 04/01/2023 | EACH OCCURRENCE \$ 2,000,000 DAMAGE TO RENTED PREMISES (Ea occurrence) \$ 1,000,000 MED EXP (Any one person) \$ 5,000 PERSONAL & ADV INJURY \$ 2,000,000 GENERAL AGGREGATE \$ 4,000,000 PRODUCTS - COMP/OP AGG \$ 4,000,000 | |
| A | AUTOMOBILE LIABILITY <input checked="" type="checkbox"/> ANY AUTO OWNED AUTOS ONLY HIRED AUTOS ONLY <input type="checkbox"/> SCHEDULED AUTOS NON-OWNED AUTOS ONLY | | Y | BUA 7018331432 | 04/01/2022 | 04/01/2023 | COMBINED SINGLE LIMIT (Ea accident) \$ 2,000,000 BODILY INJURY (Per person) \$ BODILY INJURY (Per accident) \$ PROPERTY DAMAGE (Per accident) \$ | |
| B | <input checked="" type="checkbox"/> UMBRELLA LIAB <input checked="" type="checkbox"/> OCCUR <input type="checkbox"/> EXCESS LIAB <input type="checkbox"/> CLAIMS-MADE DED <input checked="" type="checkbox"/> RETENTION \$ 25,000 | | Y | 47-UMO-303445-08 | 04/01/2022 | 04/01/2023 | EACH OCCURRENCE \$ 5,000,000 AGGREGATE \$ 5,000,000 | |
| C | WORKERS COMPENSATION AND EMPLOYERS' LIABILITY ANY PROPRIETOR/PARTNER/EXECUTIVE OFFICER/MEMBER EXCLUDED? (Mandatory in NH) If yes, describe under DESCRIPTION OF OPERATIONS below | Y/N | No | N/A | WC7018331446 | 04/01/2022 | 04/01/2023 | <input checked="" type="checkbox"/> PER STATUTE <input type="checkbox"/> OTHER E.L. EACH ACCIDENT \$ 1,000,000 E.L. DISEASE - EA EMPLOYEE \$ 1,000,000 E.L. DISEASE - POLICY LIMIT \$ 1,000,000 |

DESCRIPTION OF OPERATIONS / LOCATIONS / VEHICLES (ACORD 101, Additional Remarks Schedule, may be attached if more space is required)
City of Alexandria, its elected and appointed officials, officers, and employees are included as an Additional Insureds under the General Liability and Umbrella/Excess Liability as their interest may appear and as required by written agreement and only with respect to the liability arising out of the operations performed by or on behalf of the Named Insured.

City of Alexandria, its elected and appointed officials, officers, and employees are included as additional insureds

CERTIFICATE HOLDER

CANCELLATION

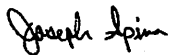
| | |
|---|---|
| City of Alexandria 301 King Street Alexandria, VA 22314 | SHOULD ANY OF THE ABOVE DESCRIBED POLICIES BE CANCELLED BEFORE THE EXPIRATION DATE THEREOF, NOTICE WILL BE DELIVERED IN ACCORDANCE WITH THE POLICY PROVISIONS. AUTHORIZED REPRESENTATIVE  |
|---|---|

© 1988-2016 ACORD CORPORATION. All rights reserved.

| Named Insured | Named Insured (cont.) |
|--|--|
| AirComm of Avon, LLC | Crown Castle Solutions LLC |
| Assurable Insurance LLC | Crown Castle South LLC |
| Atlantic Coast Communications LLC | Crown Castle Towers 05 LLC |
| CC Edge LLC | Crown Castle Towers 06-2 LLC |
| CC Holdings GS V LLC | Crown Castle Towers 09 LLC |
| CC Site Acquisitions II LLC | Crown Castle Towers LLC |
| CC Strategic Investment Corp. | Crown Castle USA Inc. |
| CC TM PA LLC | Crown Communication LLC |
| CC Towers Guarantor LLC | Crown Communication New York, Inc. |
| CC Towers Holding LLC | Fibertech Facilities Corp. |
| CCATT Holdings LLC | Global Signal Acquisitions II LLC |
| CCATT LLC | Global Signal Acquisitions III LLC |
| CCATT PR LLC | Global Signal Acquisitions IV LLC |
| CCGS Holdings Corp. | Global Signal Acquisitions LLC |
| CCPR VI Tower Newco LLC | Global Signal GP LLC |
| CCS & E LLC | Global Signal Holdings III LLC |
| CCTM Holdings LLC | Global Signal Operating Partnership, LP |
| CCTM1 LLC | GoldenState Towers LLC |
| CCTM2 LLC | GS Savings Inc. |
| CCTMO LLC | GSPN Intangibles LLC |
| ComSite Venture, Inc. | High Point Management Co. LLC |
| Coverage Plus Antennas Systems LLC | ICB Towers LLC |
| Crown Atlantic Company LLC | Interstate Tower Communications LLC |
| Crown Castle AS LLC | Intracoastal City Towers LLC |
| Crown Castle Atlantic LLC | Light Tower Clearinghouse LLC |
| Crown Castle CA Corp. | Md7 Capitol One, LLC |
| Crown Castle Fiber Enterprise LLC | MW Cell Reit 1 LLC |
| Crown Castle Fiber Holdings Corp. | MW Cell TRS 1 LLC |
| Crown Castle Fiber LLC | OP LLC |
| Crown Castle GS III Corp. | OP 2 LLC |
| Crown Castle GT Company LLC | Pinnacle Towers Acquisition Holdings LLC |
| Crown Castle GT Corp. | Pinnacle Towers Acquisition LLC |
| Crown Castle GT Holding Sub LLC | Pinnacle Towers Asset Holding LLC |
| Crown Castle Inc. f/k/a Crown Castle International Corp. | Pinnacle Towers Canada Inc. |
| Crown Castle International LLC | Pinnacle Towers III LLC |
| Crown Castle Investment Corp. | Pinnacle Towers Limited |
| Crown Castle Investment II Corp. | Pinnacle Towers LLC |
| Crown Castle MU LLC | Pinnacle Towers V Inc. |
| Crown Castle MUPA LLC | PR Site Development Corporation |
| Crown Castle NG East LLC | Radio Station WGLD LLC |
| Crown Castle Operating Company | Shaffer & Associates, Inc. |
| Crown Castle Operating LLC | Sidera Networks UK Limited (UK) |
| Crown Castle Orlando Corp. | Sierra Towers, Inc. |
| Crown Castle PR LLC | Tower Development Corporation |
| Crown Castle PR Solutions LLC | Tower Systems LLC |
| Crown Castle Puerto Rico Corp. | Tower Technology Company of Jacksonville LLC |

| Named Insured | Named Insured (cont.) |
|---|--|
| Tower Ventures III LLC | Fiber Technologies Networks, L.L.C. (NY) |
| TowerOne Partners, LLC | Fibernet Direct Florida LLC |
| TriStar Investors LLC | Fibernet Direct Holdings LLC |
| TVHT LLC | Fibernet Direct TEL LLC |
| WCP Wireless Lease Subsidiary, LLC | Fibernet Direct Texas LLC |
| WCP Wireless Site Funding LLC | Fibertech Holdings Corp. |
| WCP Wireless Site Holdco LLC | Fibertech Networks, LLC |
| WCP Wireless Site Non-RE Funding LLC | Freedom Telecommunications, LLC |
| WCP Wireless Site Non-RE Holdco LLC | Global Signal Services LLC |
| WCP Wireless Site RE Funding LLC | InfraSource FI, LLC |
| WCP Wireless Site RE Holdco LLC | InSITE Fiber of Virginia LLC |
| Merged Entities to Crown Castle Fiber LLC | InSITE Solutions LLC |
| 24/7 Chesapeake Holdings, LLC | IX2 Center, LLC |
| 24/7 Mid-Atlantic Network of Virginia, LLC | IX2 Wilshire, LLC |
| 24/7 Mid-Atlantic Network, LLC | JBCM Towers LLC |
| Access Fiber Group Holdings LLC | Light Tower Fiber New York, Inc. (NY) |
| Access Fiber Group, Inc. | Light Tower Holdings LLC |
| CA - CLEC LLC | Light Tower Management, Inc. |
| CC Castle International LLC | Light Tower Metro Fiber LLC |
| CC Edge Solutions LLC | Lighttower Fiber Infrastructure Corp. |
| CC Finance LLC | Lighttower Fiber Networks I, LLC |
| CC FN Holdings LLC | Lighttower Fiber Networks II, LLC n/k/a Crown Castle Fiber LLC |
| CC Sunesys Fiber Networks LLC | LL Q1-18, LLC |
| CC TS LLC | LTS Buyer LLC |
| CCPE Acquisitions LLC | LTS Group Holdings LLC n/k/a Crown Castle Fiber Holdings Corp |
| CCT2 Holdings LLC | LTS Intermediate Holdings A LLC |
| Chesapeake Fiber, LLC | LTS Intermediate Holdings B LLC |
| Coastal Antennas LLC | LTS Intermediate Holdings C LLC |
| Cross Connect Solutions, Inc. (PA) | Mobile Media California LLC |
| Crown Castle Atlantic LLC | Mobile Media National LLC |
| Crown Castle Augusta LLC | Modeo LLC |
| Crown Castle BP ATT LLC | NEON Transcom, Inc. |
| Crown Castle International Corp. de Puerto Rico | NewPath Networks Holding LLC |
| Crown Castle MM Holding Corp. | NewPath Networks LLC |
| Crown Castle MM Holding LLC | NY - CLEC LLC |
| Crown Castle NG Atlantic LLC | P3 CHB-1, LLC |
| Crown Castle NG Central LLC | P3 Holdings 2014 LLC |
| Crown Castle NG Networks LLC | P3 OASA-1, LLC |
| Crown Castle NG West LLC | P3 PBA-1, LLC |
| Crown Castle PT Inc. | PA - CLEC LLC |
| Crown Castle Services LLC | Pinnacle San Antonio L.L.C. |
| Crown Castle TDC LLC | Pinnacle St. Louis LLC |
| Crown Castle TLA LLC | PR TDC Corporation |
| Crown Mobile Systems, Inc. | Princeton Ancillary Services II LLC |
| DAS Development Corporation | Princeton Ancillary Services III LLC |

Crown Castle Inc.

Edition Date: 8/01/22

| Named Insured | Named Insured (cont.) |
|--|-----------------------|
| RGP Tower Group, LLC | |
| Sidera Networks, Inc. | |
| Sunesys Enterprise LLC n/k/a Crown Castle Fiber Enterprise LLC | |
| Sunesys of Massachusetts, LLC | |
| Sunesys of Virginia, Inc. | |
| Sunesys, LLC | |
| Thunder Towers LLC | |
| TowerOne 2012, LLC | |
| TowerOne Allentown 001, LLC | |
| TowerOne Bethlehem 001, LLC | |
| TowerOne Doylestown, LLC | |
| TowerOne East Rockhill 001, LLC | |
| TowerOne Marple, LLC | |
| TowerOne Middletown 001, LLC | |
| TowerOne Middletown 002, LLC | |
| TowerOne Middletown 003, LLC | |
| TowerOne North Coventry, LLC | |
| TowerOne Richland, LLC | |
| TowerOne Upper Pottsgrove 002, LLC | |
| TowerOne Upper Pottsgrove, LLC | |
| TowerOne Warminster 001, LLC | |
| TowerOne Warrington 002, LLC | |
| Towers Finco II LLC | |
| Towers Finco III LLC | |
| Towers Finco LLC | |
| WA - CLEC LLC | |
| Wilcon Holdings LLC | |
| Wilcon Operations LLC | |
| Wilshire Connection, LLC | |
| Wilshire Services, LLC | |
| Wireless Funding, LLC | |
| Wireless Realty Holdings II, LLC | |
| Wireless Revenue Properties, LLC | |
| Yankee Metro Parent, Inc. | |