

ISSUE: Permit to Demolish/Capsulate (partial) and Certificate of Appropriateness for accessory structure

APPLICANT: Martha Peterson

LOCATION: Old and Historic Alexandria District
109 Duke Street

ZONE: RM/Residential Townhouse Zone

BOARD ACTION July 21, 2021: Approved, as Submitted

On a motion by Ms. Neihardt and seconded by Mr. Spencer, the Board of Architectural Review voted to approve BAR #2021-00326 and BAR #2021-00327, as submitted. The motion carried on a vote of 6-0.

CONDITIONS OF APPROVAL

1. *The statements in archaeology conditions above marked with an asterisk “*” shall appear in the General Notes of all site plans and on all site plan sheets that involve demolition or ground disturbance (including Basement/Foundation Plans, Demolition, Erosion and Sediment Control, Grading, Landscaping, Utilities, and Sheeting and Shoring) so that on-site contractors are aware of the recommendations.

*Alexandria Archaeology recommends that the applicant/property owner call Alexandria Archaeology immediately (703-746-4399) if any buried structural remains (wall foundations, wells, privies, cisterns, etc.) or concentrations of artifacts are discovered during development. Work should cease in the area of the discovery until a City archaeologist comes to the site and records the finds.

*The applicant/property owner shall not allow any metal detection or artifact collection to be conducted on the property, unless authorized by Alexandria Archaeology

REASON

The Board felt that the design was appropriate and that the project made good use of the remaining open space.

SPEAKERS

John Savage, architect, spoke in support of the project.

DISCUSSION

There was no discussion.

STAFF RECOMMENDATION

Staff recommends reapproval of the Permit to Demolish/Capsulate (partial) and Certificate of Appropriateness for an accessory structure as submitted.

GENERAL NOTES TO THE APPLICANT

1. **APPEAL OF DECISION:** In accordance with the Zoning Ordinance, if the Board of Architectural Review denies or approves an application in whole or in part, the applicant or opponent may appeal the Board's decision to City Council on or before 14 days after the decision of the Board.
2. **COMPLIANCE WITH BAR POLICIES:** All materials must comply with the BAR's adopted policies unless otherwise specifically approved.
3. **BUILDING PERMITS:** Most projects approved by the Board of Architectural Review require the issuance of one or more construction permits by Department of Code Administration (including signs). The applicant is responsible for obtaining all necessary construction permits after receiving Board of Architectural Review approval. Contact Code Administration, Room 4200, City Hall, 703-746-4200 for further information.
4. **ISSUANCE OF CERTIFICATES OF APPROPRIATENESS AND PERMITS TO DEMOLISH:** Applicants must obtain a copy of the Certificate of Appropriateness or Permit to Demolish PRIOR to applying for a building permit. Contact BAR Staff, Room 2100, City Hall, 703-746-3833, or preservation@alexandriava.gov for further information.
5. **EXPIRATION OF APPROVALS NOTE:** In accordance with Sections 10-106(B), 10-206(B) and 10-307 of the Zoning Ordinance, any Board of Architectural Review approval will expire 12 months from the date of issuance if the work is not commenced and diligently and substantially pursued by the end of that 12-month period.
6. **HISTORIC PROPERTY TAX CREDITS:** Applicants performing extensive, certified rehabilitations of historic properties may separately be eligible for state and/or federal tax credits. Consult with the Virginia Department of Historic Resources (VDHR) prior to initiating any work to determine whether the proposed project may qualify for such credits.



Note: Staff coupled the applications for a Permit to Demolish (BAR #2022-00384) and Certificate of Appropriateness (BAR #2022-00385) for clarity and brevity. The Permit to Demolish requires a roll call vote.

UPDATE

The applicant came before the Board on July 21, 2021, for the partial demolition of a brick garden wall and gates and to construct a detached garage with a finished second story living space building; the project was then approved. The approval expired (per Section 10-106 (B) of the zoning ordinance) consequently, the applicant is requesting reapproval of the same project with the exception of the new survey (consolidating the property's two lots) and that the proposed garage has moved back 6-inches towards the 30-foot private alley.

I. APPLICANT'S PROPOSAL

The applicant requests a Permit to Demolish/Capsulate (partial) and Certificate of Appropriateness to construct an accessory structure (garage) in the rear yard at 109 Duke Street. The garage will only be obliquely visible from Duke Street because the alley adjacent and behind the subject property is private.

Permit to Demolish/Capsulate

A 40-foot-long by 6-foot-high portion of the masonry wall at the rear of the property will be demolished, as well as the existing metal gates on the east side of the wall (Figure 1).

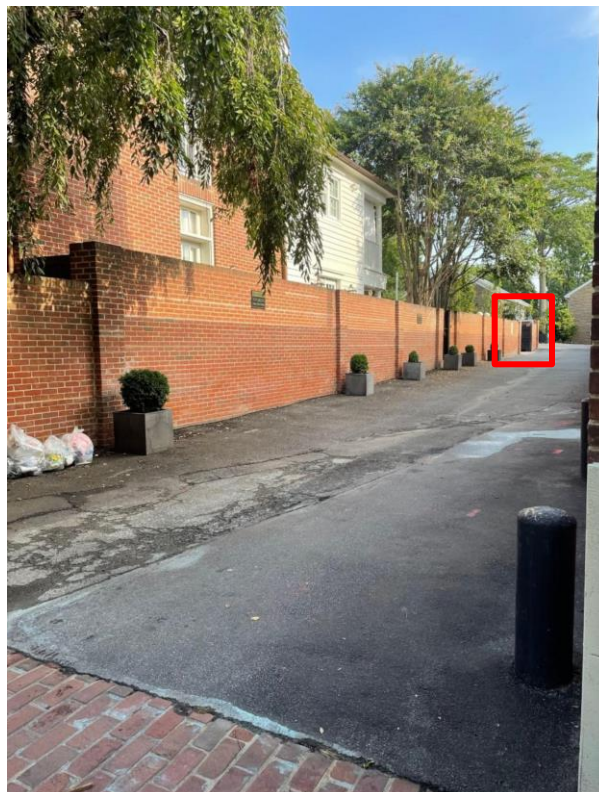

Figure 1: Red box indicates gates to be demolished.

Certificate of Appropriateness

A new 30-foot by-25 foot one-and-a-half story accessory structure (garage) will be built at the rear of the applicant's property in the rear yard. The standing seam metal gable roof will have a copula and weathervane at the peak and shed dormers facing north and south. The east elevation will have two double-hung six-over-six windows on the first floor and a round window and louvered vent on the gable end. Materials on the addition consist of standing seam metal, Kolbe Heritage Series double-hung and casement style double-glazed wood windows, Artisan lap siding (James Hardie), decorative wood brackets and Bevolo electric carriage style lights.

The area where the double gates are removed on the east will be infilled with a new masonry wall to match the existing and a smaller solid composite gate for pedestrian access to the yard.

Site context

The alley to the east and north is private. Views to the new garage will be limited to what is visible from the sidewalk along Duke Street.

II. HISTORY

According to Ethelyn Cox in Historic Alexandria Virginia Street by Street, the two-story brick house at 109 Duke Street was constructed between **1801 and 1803** by Ephraim Mills, a trunk maker. A rear ell at 109 Duke Street is shown on G.M. Hopkins' 1877 Atlas of Alexandria, the first year the house was mapped. By July of 1885, according to the Sanborn Fire Insurance Map, a one-story addition had been constructed on the ell.

Previous BAR Approvals

- | | |
|-----------------|--|
| 1980: | The BAR approved an addition to the east side of the historic house (setback). |
| April 19, 2006: | The BAR approved the construction of a new brick wall, a storage shed and garden fence inside of the brick wall (BAR Case #2006-0066). |
| April 2, 2014: | Staff administratively approved the replacement of certain windows (BAR Case #2014-0091). |
| June 20, 2018: | The BAR approved the front porch and re-approved the rear addition (BAR Case#2017-0165) |
| July 21, 2021: | The BAR approved the construction of a detached garage and the partial demolition of the garden brick wall and gates. (BAR Case#2021-00326 and BAR2021-00327). Expired on July 21, 2022. |

III. ANALYSIS

Permit to Demolish/Capsulate

In considering a Permit to Demolish/Capsulate, the Board must consider the following criteria set forth in the Zoning Ordinance, §10-105(B), which relate only to the subject property and not to neighboring properties. The Board has purview of the proposed demolition/capsulation regardless of visibility.

Standard	Description of Standard	Standard Met?
(1)	Is the building or structure of such architectural or historical interest that its moving, removing, capsulating or razing would be to the detriment of the public interest?	No
(2)	Is the building or structure of such interest that it could be made into a historic shrine?	No
(3)	Is the building or structure of such old and unusual or uncommon design, texture and material that it could not be reproduced or be reproduced only with great difficulty?	No
(4)	Would retention of the building or structure help preserve the memorial character of the George Washington Memorial Parkway?	N/A
(5)	Would retention of the building or structure help preserve and protect an historic place or area of historic interest in the city?	No
(6)	Would retention of the building or structure promote the general welfare by maintaining and increasing real estate values, generating business, creating new positions, attracting tourists, students, writers, historians, artists and artisans, attracting new residents, encouraging study and interest in American history, stimulating interest and study in architecture and design, educating citizens in American culture and heritage, and making the city a more attractive and desirable place in which to live?	No

In the opinion of staff, none of the criteria for demolition and capsulation are met and the Permit to Demolish/Capsulate should be granted. The masonry wall which will be demolished is not historic, nor are the metal gates on the east elevation. The materials to be demolished are not of unusual or uncommon design and could be reproduced easily.

Certificate of Appropriateness

According to the *Design Guidelines*, “Freestanding accessory structures should complement, not compete with, the architecture of the main building” and “Exterior finishes for accessory structures should be selected to complement that main building.” In the opinion of staff, the use of compatible yet modern materials – such as fiber cement siding and double-glazed wood windows – will help to distinguish the new garage from the early 19th century building, while clearly reading

as a new site feature. The design of the addition, with its gable roof, compliments the original portion of the house and the recently approved addition, which is currently under construction.

Staff recommends approval of the application, as submitted, and notes the recommendations of Alexandria Archaeology.

STAFF

Stephanie Sample, Historic Preservation Planner, Planning & Zoning

Marina Novaes, Historic Preservation Planner, Planning & Zoning

Tony LaColla, AICP, Land Use Services Division Chief, Planning & Zoning

IV. CITY DEPARTMENT COMMENTS

Legend: C- code requirement R- recommendation S- suggestion F- finding

Zoning

F-1 The proposed new garage meets the FAR, side and rear setbacks, and open space requirements of the RM zone. Half of the rear alley counts towards the rear setback requirement and the new pool (minus the pool mechanical equipment) counts towards open space. Only one 5-ft east side yard setback is required as the west side of the dwelling is attached.

F-2 The proposed two-story rear garage complies with zoning.

Code Administration

F-1 No garage plan.

Transportation and Environmental Services

R-1 The building permit must be approved and issued prior to the issuance of any permit for demolition, if a separate demolition permit is required. (T&ES)

R-2 Applicant shall be responsible for repairs to the adjacent city right-of-way if damaged during construction activity. (T&ES)

R-3 No permanent structure may be constructed over any existing private and/or public utility easements. It is the responsibility of the applicant to identify any and all existing easements on the plan. (T&ES)

F-1 After review of the information provided, an approved grading plan is not required at this time. Please note that if any changes are made to the plan it is suggested that T&ES be included in the review. (T&ES)

F-2 If the alley located at the rear of the parcel is to be used at any point of the construction process the following will be required:

For a Public Alley - The applicant shall contact T&ES, Construction Permitting & Inspections at (703) 746-4035 to discuss any permits and accommodation requirements that will be required.

For a Private Alley - The applicant must provide proof, in the form of an affidavit at a minimum, from owner of the alley granting permission of use. (T&ES)

- C-1 The applicant shall comply with the City of Alexandria's Solid Waste Control, Title 5, Chapter 1, which sets forth the requirements for the recycling of materials (Sec. 5-1-99). (T&ES)
- C-2 The applicant shall comply with the City of Alexandria's Noise Control Code, Title 11, Chapter 5, which sets the maximum permissible noise level as measured at the property line. (T&ES)
- C-3 Roof, surface and sub-surface drains be connected to the public storm sewer system, if available, by continuous underground pipe. Where storm sewer is not available applicant must provide a design to mitigate impact of stormwater drainage onto adjacent properties and to the satisfaction of the Director of Transportation & Environmental Services. (Sec.5-6-224) (T&ES)
- C-4 All secondary utilities serving this site shall be placed underground. (Sec. 5-3-3) (T&ES)
- C-5 Any work within the right-of-way requires a separate permit from T&ES. (Sec. 5-2) (T&ES)
- C-6 All improvements to the city right-of-way such as curbing, sidewalk, driveway aprons, etc. must be city standard design. (Sec. 5-2-1) (T&ES)

Alexandria Archaeology

- F-1 Ephraim Mills, a trunk maker, built the house at 109 Duke St. in the first few years of the nineteenth century. Historic maps indicate that the proposed detached garage will be built where an early nineteenth century outbuilding once stood on the back of the property. The property may contain significant archaeological information pertaining to early nineteenth century Alexandria.

Archaeology Recommendations

- R-1.* Alexandria Archaeology recommends that the applicant/property owner call Alexandria Archaeology immediately (703-746-4399) if any buried structural remains (wall foundations, wells, privies, cisterns, etc.) or concentrations of artifacts are discovered during development. Work should cease in the area of the discovery until a City archaeologist comes to the site and records the finds.

R-2.* The applicant/property owner shall not allow any metal detection or artifact collection to be conducted on the property, unless authorized by Alexandria Archaeology.

**The statements in archaeology conditions above marked with an asterisk “*” shall appear in the General Notes of all site plans and on all site plan sheets that involve demolition or ground disturbance (including Basement/Foundation Plans, Demolition, Erosion and Sediment Control, Grading, Landscaping, Utilities, and Sheeting and Shoring) so that on-site contractors are aware of the recommendations*

V. ATTACHMENTS

- 1 – Supplemental Materials*
- 2 – Application for Materials*

BAR Case # _____

ADDRESS OF PROJECT: 109 Duke Street

DISTRICT: Old & Historic Alexandria Parker – Gray 100 Year Old Building

TAX MAP AND PARCEL: 075.03-02-31 ZONING: RM

APPLICATION FOR: *(Please check all that apply)*

- CERTIFICATE OF APPROPRIATENESS
- PERMIT TO MOVE, REMOVE, ENCAPSULATE OR DEMOLISH
(Required if more than 25 square feet of a structure is to be demolished/impacted)
- WAIVER OF VISION CLEARANCE REQUIREMENT and/or YARD REQUIREMENTS IN A VISION CLEARANCE AREA *(Section 7-802, Alexandria 1992 Zoning Ordinance)*
- WAIVER OF ROOFTOP HVAC SCREENING REQUIREMENT *(Section 6-403(B)(3), Alexandria 1992 Zoning Ordinance)*

Applicant: Property Owner Business *(Please provide business name & contact person)*

Name: Martha Peterson

Address: 109 Duke Street

City: Alexandria State: VA Zip: 22314

Phone: (202) 230-8888 E-mail: marthashawpeterson@icloud.com

Authorized Agent *(if applicable)*: Attorney Architect _____

Name: John B. Savage

Phone: (703) 462-3994

E-mail: savage.arch2@netzero.net

Legal Property Owner:

Name: Steven and Martha Peterson

Address: 109 Duke Street

City: Alexandria State: VA Zip: 22314

Phone: (202) 230-8888 E-mail: marthashawpeterson@icloud.com

- Yes No Is there an historic preservation easement on this property?
- Yes No If yes, has the easement holder agreed to the proposed alterations?
- Yes No Is there a homeowner's association for this property?
- Yes No If yes, has the homeowner's association approved the proposed alterations?

If you answered yes to any of the above, please attach a copy of the letter approving the project.

NATURE OF PROPOSED WORK: *Please check all that apply*

- NEW CONSTRUCTION
- EXTERIOR ALTERATION: *Please check all that apply.*
 - awning fence, gate or garden wall HVAC equipment shutters
 - doors windows siding shed
 - lighting pergola/trellis painting unpainted masonry
 - other _____
- ADDITION
- DEMOLITION/ENCAPSULATION
- SIGNAGE

DESCRIPTION OF PROPOSED WORK: *Please describe the proposed work in detail (Additional pages may be attached).*

Construction of a detached garage with finished conditioned space on the second floor. The garage is accessed off of an existing 30' wide private alley, made possible with the removal of a portion of the existing north brick wall. Removal of two existing open metal gates and replacement with a solid gate and a matching brick wall. Two of the garage elevations are not visible from the public way. The other two elevations have visibility limited by an existing 6' high brick wall and the fact that the closest portion of the garage is 119' from the public way.

SUBMITTAL REQUIREMENTS:

Items listed below comprise the **minimum supporting materials** for BAR applications. Staff may request additional information during application review. Please refer to the relevant section of the *Design Guidelines* for further information on appropriate treatments.

Applicants must use the checklist below to ensure the application is complete. Include all information and material that are necessary to thoroughly describe the project. Incomplete applications will delay the docketing of the application for review. Pre-application meetings are required for all proposed additions. All applicants are encouraged to meet with staff prior to submission of a completed application.

Demolition/Encapsulation : *All applicants requesting 25 square feet or more of demolition/encapsulation must complete this section. Check N/A if an item in this section does not apply to your project.*

- N/A
- Survey plat showing the extent of the proposed demolition/encapsulation.
- Existing elevation drawings clearly showing all elements proposed for demolition/encapsulation.
- Clear and labeled photographs of all elevations of the building if the entire structure is proposed to be demolished.
- Description of the reason for demolition/encapsulation.
- Description of the alternatives to demolition/encapsulation and why such alternatives are not considered feasible.

Additions & New Construction: Drawings must be to scale and should not exceed 11" x 17" unless approved by staff. Check N/A if an item in this section does not apply to your project.

- N/A Scaled survey plat showing dimensions of lot and location of existing building and other structures on the lot, location of proposed structure or addition, dimensions of existing structure(s), proposed addition or new construction, and all exterior, ground and roof mounted equipment.
- FAR & Open Space calculation form.
- Clear and labeled photographs of the site, surrounding properties and existing structures, if applicable.
- Existing elevations must be scaled and include dimensions.
- Proposed elevations must be scaled and include dimensions. Include the relationship to adjacent structures in plan and elevations.
- Materials and colors to be used must be specified and delineated on the drawings. Actual samples may be provided or required.
- Manufacturer's specifications for materials to include, but not limited to: roofing, siding, windows, doors, lighting, fencing, HVAC equipment and walls.
- For development site plan projects, a model showing mass relationships to adjacent properties and structures.

Signs & Awnings: One sign per building under one square foot does not require BAR approval unless illuminated. All other signs including window signs require BAR approval. Check N/A if an item in this section does not apply to your project.

- N/A Linear feet of building: Front: _____ Secondary front (if corner lot): _____
- Square feet of existing signs to remain: _____
- Photograph of building showing existing conditions.
- Dimensioned drawings of proposed sign identifying materials, color, lettering style and text.
- Location of sign (show exact location on building including the height above sidewalk).
- Means of attachment (drawing or manufacturer's cut sheet of bracket if applicable).
- Description of lighting (if applicable). Include manufacturer's cut sheet for any new lighting fixtures and information detailing how it will be attached to the building's facade.

Alterations: Check N/A if an item in this section does not apply to your project.

- N/A Clear and labeled photographs of the site, especially the area being impacted by the alterations, all sides of the building and any pertinent details.
- Manufacturer's specifications for materials to include, but not limited to: roofing, siding, windows, doors, lighting, fencing, HVAC equipment and walls.
- Drawings accurately representing the changes to the proposed structure, including materials and overall dimensions. Drawings must be to scale.
- An official survey plat showing the proposed locations of HVAC units, fences, and sheds.
- Historic elevations or photographs should accompany any request to return a structure to an earlier appearance.

ALL APPLICATIONS: *Please read and check that you have read and understand the following items:*

- I have submitted a filing fee with this application. (Checks should be made payable to the City of Alexandria. Please contact staff for assistance in determining the appropriate fee.)
- I understand the notice requirements and will return a copy of the three respective notice forms to BAR staff at least five days prior to the hearing. If I am unsure to whom I should send notice I will contact Planning and Zoning staff for assistance in identifying adjacent parcels.
- I, the applicant, or an authorized representative will be present at the public hearing.
- I understand that any revisions to this initial application submission (including applications deferred for restudy) must be accompanied by the BAR Supplemental form and revised materials.

The undersigned hereby attests that all of the information herein provided including the site plan, building elevations, prospective drawings of the project, and written descriptive information are true, correct and accurate. The undersigned further understands that, should such information be found incorrect, any action taken by the Board based on such information may be invalidated. The undersigned also hereby grants the City of Alexandria permission to post placard notice as required by Article XI, Division A, Section 11-301(B) of the 1992 Alexandria City Zoning Ordinance, on the property which is the subject of this application. The undersigned also hereby authorizes the City staff and members of the BAR to inspect this site as necessary in the course of research and evaluating the application. The applicant, if other than the property owner, also attests that he/she has obtained permission from the property owner to make this application.

APPLICANT OR AUTHORIZED AGENT:

Signature: 

Printed Name: John B. Savage, authorized agent for the owner

Date: August 8, 2022



Department of Planning and Zoning

Floor Area Ratio and Open Space Calculations

as of 12/20/18

B

A. Property Information

A1. 109 Duke Street RM
 Street Address Zone

A2. 5,933.00 x 1.50 = 8,899.50
 Total Lot Area Floor Area Ratio Allowed by Zone Maximum Allowable Floor Area

B. Existing Gross Floor Area

<u>Existing Gross Area</u>		<u>Allowable Exclusions**</u>		
Basement	253.00	Basement**	253.00	B1. 4,897.00 Sq. Ft. Existing Gross Floor Area*
First Floor	1,962.00	Stairways**		B2. 253.00 Sq. Ft. Allowable Floor Exclusions**
Second Floor	1,725.00	Mechanical**		B3. 4,644.00 Sq. Ft. Existing Floor Area Minus Exclusions (subtract B2 from B1)
Third Floor	755.00	Attic less than 7'***		Comments for Existing Gross Floor Area
Attic	0.00	Porches**		
Porches	202.00	Balcony/Deck**		
Balcony/Deck		Lavatory***		
Lavatory***		Other**		
Other**		Other**		
B1. Total Gross	4,897.00	B2. Total Exclusions	253.00	

C. Proposed Gross Floor Area

<u>Proposed Gross Area</u>		<u>Allowable Exclusions**</u>		
Basement		Basement**		C1. 1,459.00 Sq. Ft. Proposed Gross Floor Area*
First Floor	809.00	Stairways**	36.00	C2. 45.00 Sq. Ft. Allowable Floor Exclusions**
Second Floor	596.00	Mechanical**	9.00	C3. 1,414.00 Sq. Ft. Proposed Floor Area Minus Exclusions (subtract C2 from C1)
Third Floor		Attic less than 7'***		
Attic		Porches**		
Porches		Balcony/Deck**		
Balcony/Deck	48.00	Lavatory***		
Lavatory***	6.00	Other**		
Other		Other**		
C1. Total Gross	1,459.00	C2. Total Exclusions	45.00	

Notes

*Gross floor area is the sum of all areas under roof of a lot, measured from the face of exterior walls, including basements, garages, sheds, gazebos, guest buildings and other accessory buildings.

** Refer to the Zoning Ordinance (Section 2-145(B)) and consult with Zoning Staff for information regarding allowable exclusions. Sections may also be required for some exclusions.

***Lavatories may be excluded up to a maximum of 50 square feet, per lavatory. The maximum total of excludable area for lavatories shall be no greater than 10% of gross floor area.

D. Total Floor Area

D1. 6,058.00 Sq. Ft.
Total Floor Area (add B3 and C3)

D2. 8,899.50 Sq. Ft.
Total Floor Area Allowed by Zone (A2)

E. Open Space

E1. 3,371.85 Sq. Ft.
Existing Open Space

E2. 2,076.55 Sq. Ft.
Required Open Space

E3. 2,096.69 Sq. Ft.
Proposed Open Space

The undersigned hereby certifies and attests that, to the best of his/her knowledge, the above computations are true and correct.

Signature: *John B. Savage*

Date: August 8, 2022

OWNERSHIP AND DISCLOSURE STATEMENT

Use additional sheets if necessary

1. Applicant. State the name, address and percent of ownership of any person or entity owning an interest in the applicant, unless the entity is a corporation or partnership, in which case identify each owner of more than three percent. The term ownership interest shall include any legal or equitable interest held at the time of the application in the real property which is the subject of the application.

Name	Address	Percent of Ownership
1. Martha Peterson	109 Duke Street, Alexandria, VA	50
2. Steven Peterson	109 Duke Street, Alexandria, VA	50
3.		

2. Property. State the name, address and percent of ownership of any person or entity owning an interest in the property located at 109 DUKE STREET (address), unless the entity is a corporation or partnership, in which case identify each owner of more than three percent. The term ownership interest shall include any legal or equitable interest held at the time of the application in the real property which is the subject of the application.

Name	Address	Percent of Ownership
1. Martha Peterson	109 Duke Street, Alexandria, VA	50
2. Steven Peterson	109 Duke Street, Alexandria, VA	50
3.		

3. Business or Financial Relationships. Each person or entity listed above (1 and 2), with an ownership interest in the applicant or in the subject property is required to disclose **any** business or financial relationship, as defined by Section 11-350 of the Zoning Ordinance, existing at the time of this application, or within the 12-month period prior to the submission of this application with any member of the Alexandria City Council, Planning Commission, Board of Zoning Appeals or either Boards of Architectural Review.

Name of person or entity	Relationship as defined by Section 11-350 of the Zoning Ordinance	Member of the Approving Body (i.e. City Council, Planning Commission, etc.)
1. Martha Peterson	None	Not applicable
2. Steven Peterson	None	Not applicable
3.		

NOTE: Business or financial relationships of the type described in Sec. 11-350 that arise after the filing of this application and before each public hearing must be disclosed prior to the public hearings.

As the applicant or the applicant's authorized agent, I hereby attest to the best of my ability that the information provided above is true and correct.

August 8, 2022
Date

John B. Savage, authorized agent
Printed Name

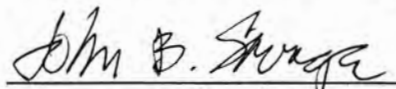
Signature



**PHOTOGRAPH OF 18-FOOT WIDE PRIVATE ALLEY
AS SEEN FROM DUKE STREET**



PHOTOGRAPH OF REAR SECTION OF LOT
AS SEEN FROM DUKE STREET PUBLIC SIDEWALK

DEMOLITION EXPLANATION

This project involves removal of two car entrance gates a portion of the north rear brick wall. The entrance gates now provide security for two cars that are parked at the rear of the lot. With the planned construction of the garage having the garage doors being located off of the 30-foot wide alley, these entrance gates are no longer needed.

The 30-foot wide alley is much easier for cars to maneuver than the 18-foot alley. A logical solution would be to have the garage doors face the 30-foot alley. We propose removing a portion of the 40-foot long north brick wall in order to construct a garage with two 9-foot wide garage doors. The garage footprint of 25-feet by 30-feet allows a 5-foot setback from each side property line and a 3 feet 6 inch setback from the rear property line.

Neither the entrance gates or the brick wall is historic. The brick wall infill along the east property line will be accomplished using bricks matching existing.

 **REQUEST A SAMPLE**



ARTISAN LAP SIDING BY JAMES HARDIE

Thick, fiber cement lap siding elevates the aesthetic of traditional wood siding with lower maintenance.

**NOTE: SIDING TO BE PAINTED GRAY.
TRIM AND WINDOW COMPONENTS TO BE PAINTED WHITE**

Panel Specs

Thickness:	0.625"		
Weight:	4.55 LBS./SQ. FT.		
Length:	144"		
Widths:	5.25"	7.25"	8.25"
Exposure:	4"	6"	7"
Color:	COMES PRIMED FOR PAINT		



KOLBE

WINDOWS & DOORS

HERITAGE SERIES
TRADITIONAL DOUBLE HUNG - OPERATING - STANDARD PERFORMANCE
49/16" JAMB - FULL SCREEN
DOUBLE PANE GLASS
VERTICAL CROSS SECTION

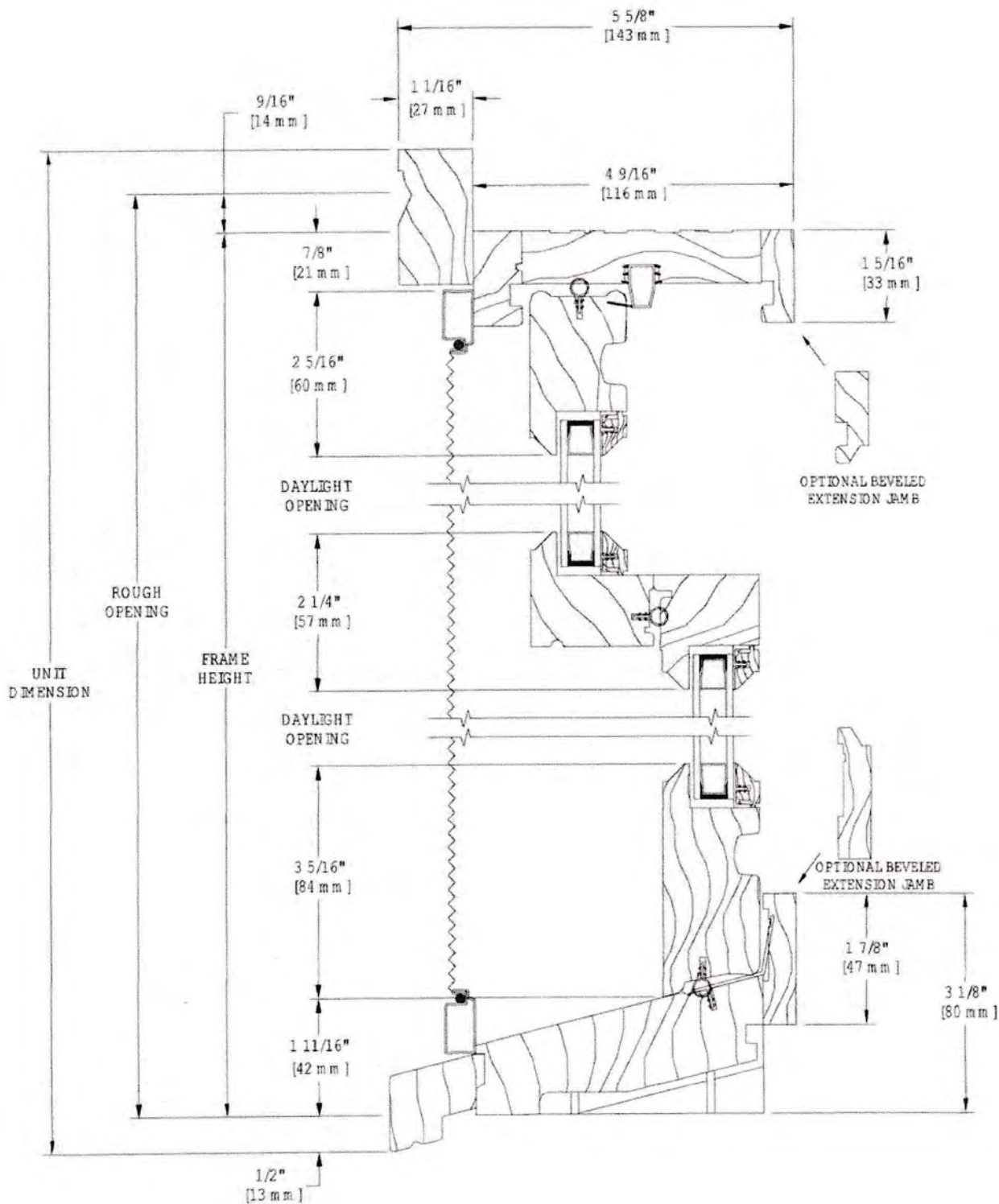

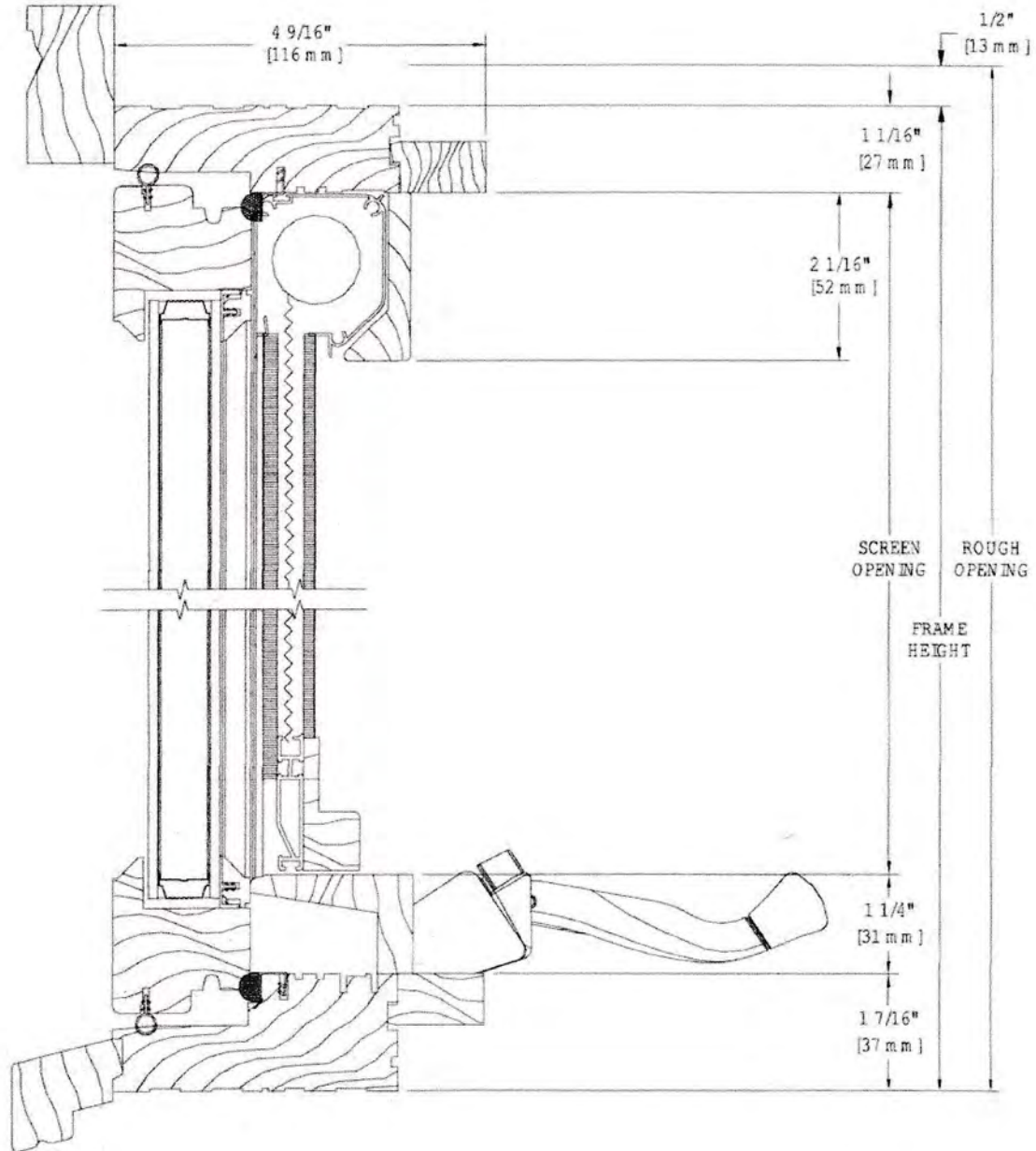



CUPOLA MANUFACTURED BY CUPOLAS DIRECT



MORTON CUPOLAS (S3M)

Be the first to review this product (<https://cupolasdirect.com/morton-cupolas-s3mv.html#review-form>)

Item Code: S3M

- Available in 9 sizes from 18" to 72" - detailed measurements available available under the size selector **42" SIZE SELECTED**

- Fits up to 10:12 pitch roof standard
- Base extension available to accommodate 12:12 pitch
- Hand made by Amish craftsmen in Lancaster County, Pennsylvania
- Choose from solid 3/4" thick vinyl board construction or ~~3/4" thick unprimed western red cedar~~
- Vinyl is maintenance free and rot free and it will not cup or decay
- Simple louvered design with concave roof style
- Hand laid 24 gauge copper roof or your choice of 25 colors of steel roof available
- Optional 25 cupola body paint colors available
- Pest control screening optional
- Built in mount to accommodate 3/4" diameter weathervane or finial mounting rod
- Optional clapboard base siding available
- Optional trim kit package, including crown molding below the roof line and accent trim on the base, available
- Rubber weathervane hole plug included
- Stainless steel exterior hardware
- Vinyl is paintable, if desired (we recommend Krylon Fusion)
- Suitable for windy and coastal applications with engineer certified 120MPH wind rating
- Basic cupola installation instructions ([/installation-guides/](#)) included
- Compatible with most building styles
- Check out our Sizing Chart ([/sizing-chart/](#)) & Customer Photo ([/customer-photos/](#)) pages for more information
- Adds uniqueness and curb appeal to your home or building
- Shipping will be calculated during checkout for delivery within the continental US states
- 26" cupolas and smaller ship via UPS Ground
- 27" cupolas and larger ship via motor freight
- Call us or contact us by email with any questions

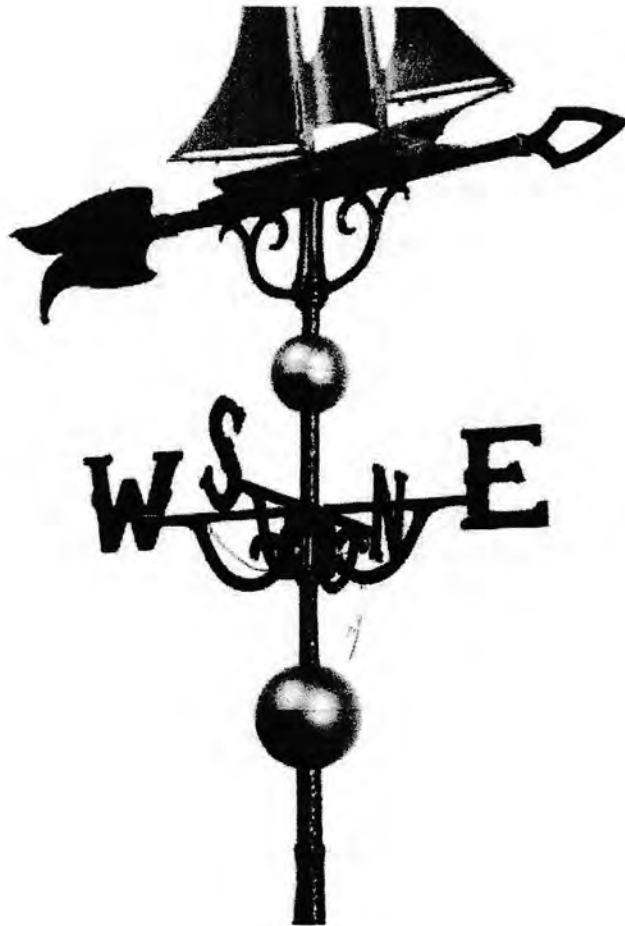

WEATHERVANE MANUFACTURED BY CUPOLAS DIRECT

LARGE ALUMINUM YACHT WEATHERVANE (AWV-02123)

Be the first to review this product (<https://cupolasdirect.com/large-aluminum-yacht-weather-vane-awv-02123.html#review-form>)

Item Code: AWV-02123

QTY: 1 

→ the perfect alternative to an all-copper weathervane. All hardware necessary for cupola installation and the assembly instructions are included with every piece. Ornament size: 18 1/4"L x 13 3/4"H with 33 1/2"L arrow. Made in the USA!

Fully functional cast aluminum weathervane, finished with a trademark Alumi-Shield process that protects against the harshest weather and environmental elements. This process extends the product life and maintains the weathervane look and function. The distinctive copper colored ornament and globes provide a complimentary topper to your cupola. Ideal for cupolas ranging in base size from 32" to 48". If your cupola doesn't have a copper roof, this is

15

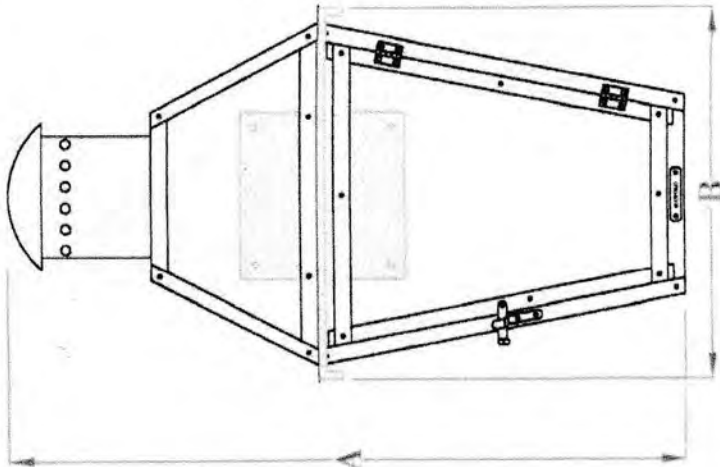

FRONT VIEW
(NTS)

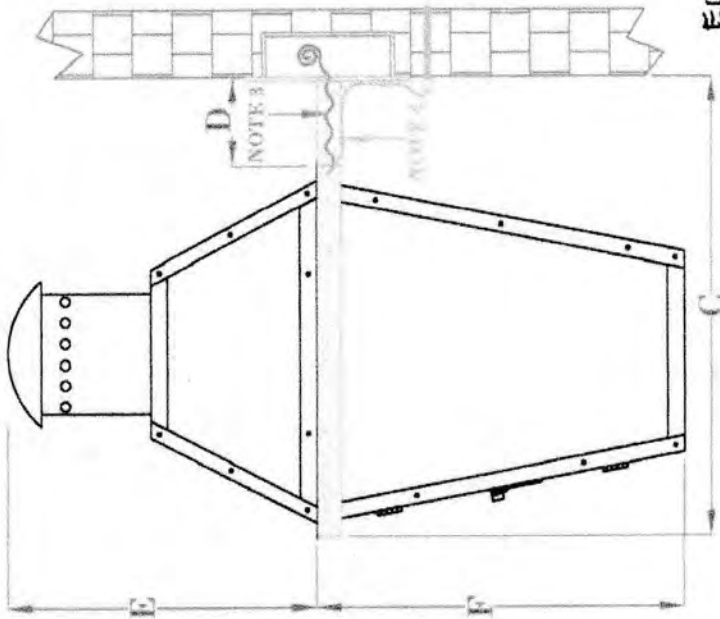

SIDE VIEW
(NTS)



ISOMETRIC VIEW
(NTS-BRACKET ONLY)

ELECTRIC MODEL CHOSEN



SIZE:	14"	18"	21"	24"	27"	30"	36"
A:	14 1/4"	17 3/4"	20 1/2"	25 1/4"	26 1/4"	30 5/8"	37"
B:	9 1/4"	10 1/2"	11 1/2"	13 1/4"	14 1/2"	17 1/2"	21 1/2"
C:	11 3/4"	13"	14"	15 3/4"	17"	20"	24"
D:	2 1/2"	2 1/2"	2 1/2"	2 1/2"	2 1/2"	2 1/2"	2 1/2"
E:	6 1/4"	7 5/8"	9 3/8"	12 3/8"	11 7/8"	14 1/2"	17 3/8"
F:	8"	10 1/8"	11 1/8"	12 7/8"	14 3/8"	16 1/8"	19 5/8"

NOTES:

1. MOUNTING HARDWARE ARE SUPPLIED BY OTHERS
2. FIXTURES ARE HANDCRAFTED. DIMENSIONS MAY VARY PLUS OR MINUS 1/4"
3. ELECTRIC LIGHTS SUPPLIED WITH 18/2 WIRE WITH GROUND
4. GAS LIGHTS SUPPLIED WITH 3/16" COPPER GAS LINE AND 3/8" x 1/4" GAS LINE ADAPTOR

BEVOLO GAS & ELECTRIC LIGHTS

LIGHT: FRENCH QUARTER

BRACKET: ORIGINAL BRACKET MOUNT

DRW BY: JJC

DATE:

11-30-17

APP. BY: JJC

REVISION:

5

COPYRIGHT 2017, BEVOLO GAS & ELECTRIC LIGHTS. DRAWINGS & DESIGNS ARE OWNED BY BEVOLO AND REMAIN THE SOLE AND EXCLUSIVE PROPERTY OF BEVOLO GAS & ELECTRIC LIGHTS. DRAWINGS AND DESIGNS SHALL NOT BE DUPLICATED IN WHOLE OR PART.

EVERSEAM™

Attractive Design

The Everseam™ panel has the elegant look of a traditional style standing seam roof, with the strength and durability of high strength 24-gauge steel. Our high-quality, pre-painted metal roof affords an attractive life cycle cost as they will not crack, shrink, or erode. This makes them a long lasting alternative to many conventional roofing materials. A homeowner is certain to achieve a designer look from our wide selection of styles and colors, creating an aesthetically pleasing appearance that will have a positive influence on re-sale.

Superior Strength

Everseam™ is 20" (+/- 1/4") wide with a 1 1/2" high seam. The integral locking seam is held in place by concealed metal clips, and is installed over a waterproof solid substrate. The absence of exposed fasteners and the weather-tight side lap, allow for applications on roof pitches as low as a 3:12. Everseam™'s durability and aesthetic appearance make it an ideal choice for residential roofing applications.



SERIES	24 GAUGE
SUBSTRATE	GALVALUME®
FINISH	FLUROPON®
FILM INTEGRITY	35 YEARS
FADE OR CHALK	35 YEARS
PERFORMANCE	25 YEARS

Available Profiles

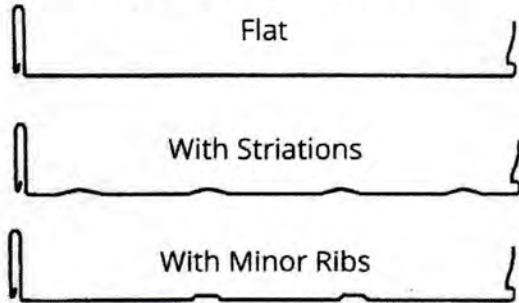

UL Ratings

- UL 790 CLASS A FIRE RATING
- UL 580 CLASS 90 UPLIFT
- UL 2218 CLASS 4 HAIL



MID-ATLANTIC
10 Enterprise Court
Lebanon, PA 17042

CENTRAL
161 Grand Valley Ave.
Orwell, OH 44076

MIDWEST
7180 N 050 E
Howe, IN 46746

NEW ENGLAND
24 JR Mains Drive
Bridgton, ME 04009

WWW.EVERLASTROOFING.COM | TOLL FREE: 888.339.0059

COMMERCIAL SNOW GUARDS

RT-200

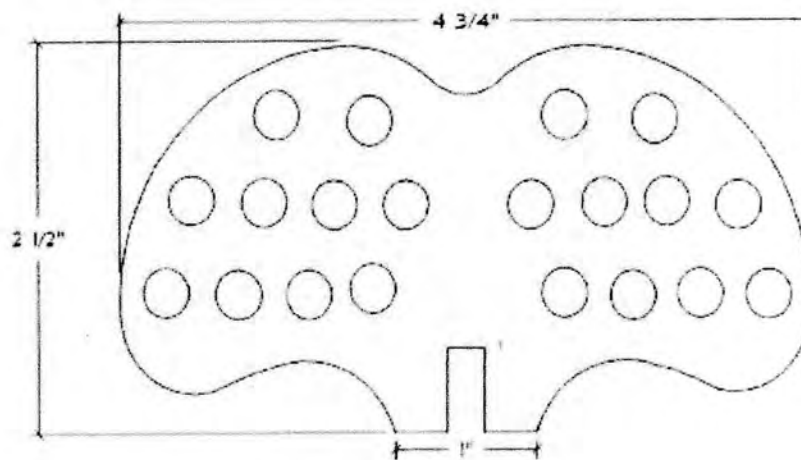
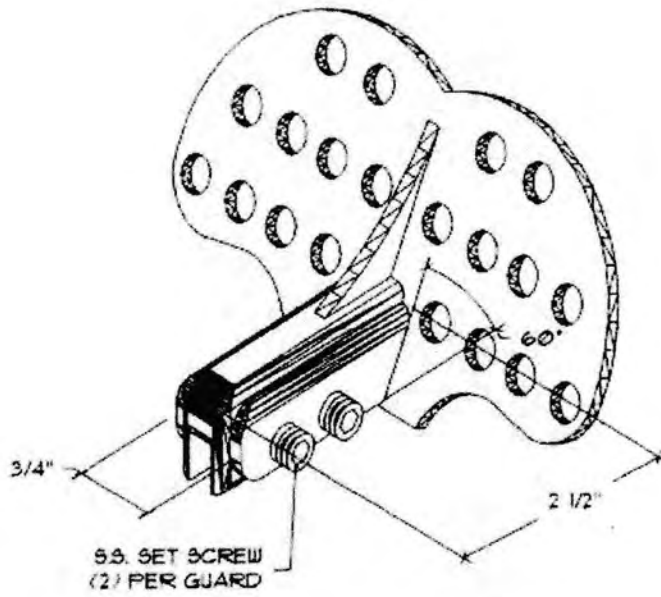

Corbels & Brackets
Variety Corbels & Brackets
Rustic Corbels & Brackets
Rustic Wood Brackets
Thorton Traditional Rough Sawn Bracket

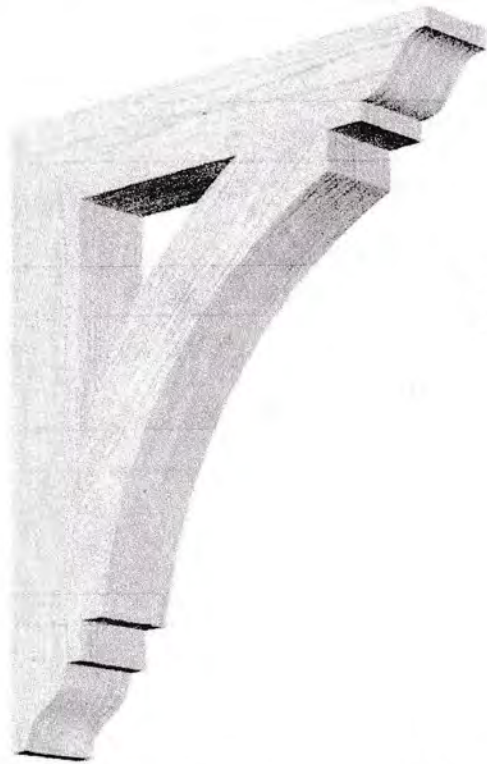

WOOD BRACKET MANUFACTURED BY
ERENA WOOD PRODUCTS



**3 1/2"W X 20"D X 24"H THORTON TRADITIONAL
SMOOTH BRACKET, DOUGLAS FIR**

Item No.: BKT04X20X24THR01SDF

(46)

Our Rustic Collection is an instant classic. Our Rustic wood millwork utilizes the technologies of today to build the 'clog and timber' wood products that have been in

Product Data

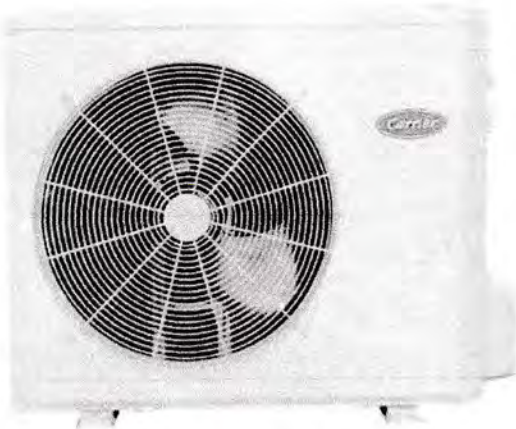

Fig. 1 —38MPRA Unit

NOTE: Images are for illustration purposes only. Actual models may differ slightly.

INDUSTRY LEADING FEATURES / BENEFITS

A PERFECT BLEND BETWEEN BUDGET LIMITS, ENERGY SAVINGS AND COMFORT

The ductless systems are a matched combination of an outdoor condensing unit and an indoor fan coil unit connected only by refrigerant tubing and wires. The ductless system permits creative solutions to design problems such as:

- Add-ons to current space (an office or family room addition)
- Special space requirements
- When changes in the load cannot be handled by the existing system
- When adding air conditioning to spaces that are heated by hydronic or electric heat and have no ductwork
- Historical renovations or any application where preserving the look of the original structure is essential.

The ideal compliment to your ducted system when it is impractical or prohibitively expensive to use ductwork.

The compact indoor fan coil units take up very little space in the room and do not obstruct windows. The fan coils are attractively styled to blend with most room decors. Advanced system components incorporate innovative technology to provide reliable cooling performance at low sound levels.

TABLE OF CONTENTS

INDUSTRY LEADING FEATURES / BENEFITS	1
BENEFITS.....	2
MODEL NUMBER NOMENCLATURE.....	3
STANDARD FEATURES AND ACCESSORIES.....	4
DIMENSIONS	5
CLEARANCES.....	7
SPECIFICATIONS	8
COMPATIBILITY	8
PERFORMANCE - HIGH WALL	8
COOLING PERFORMANCE - HIGH WALL.....	9
HEATING PERFORMANCE - HIGH WALL	10
APPLICATION DATA.....	11
WIRING.....	12
ELECTRICAL DATA	14
WIRING DIAGRAMS.....	15
GUIDE SPECIFICATIONS.....	18

Specifications subject to change without notice.

DIMENSIONS

Sizes 9K and 12K

SYSTEM SIZE		HEIGHT (H) IN. (MM)	WIDTH (W) IN. (MM)	DEPTH (D) IN. (MM)	WEIGHT-NET LBS. (KG)
9K	(208/230V)	27.64 (702)	33.27 (845)	14.29 (363)	107.59 (48.8)
12K	(208/230V)	27.64 (702)	33.27 (845)	14.29 (363)	108.47 (49.2)

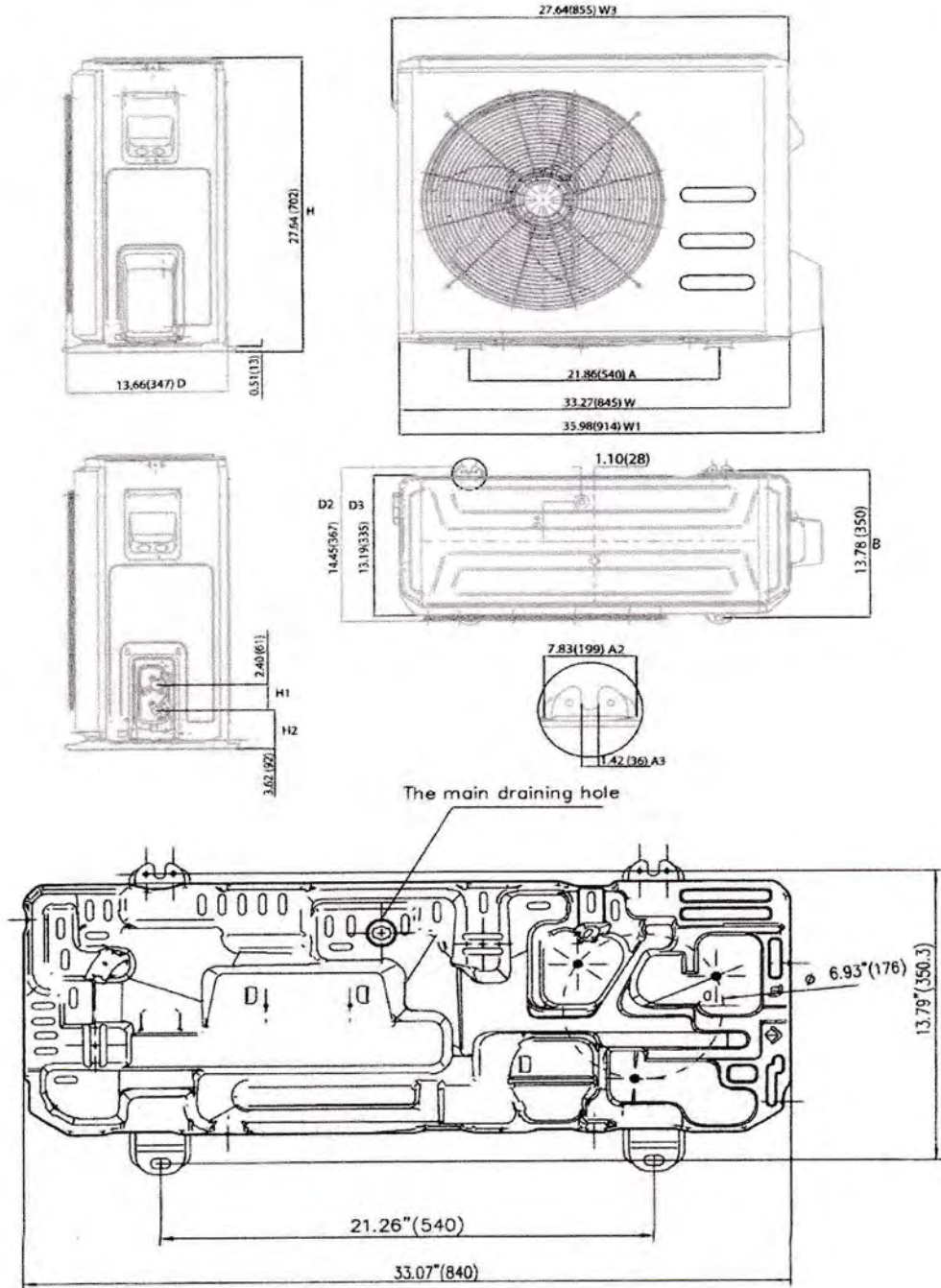
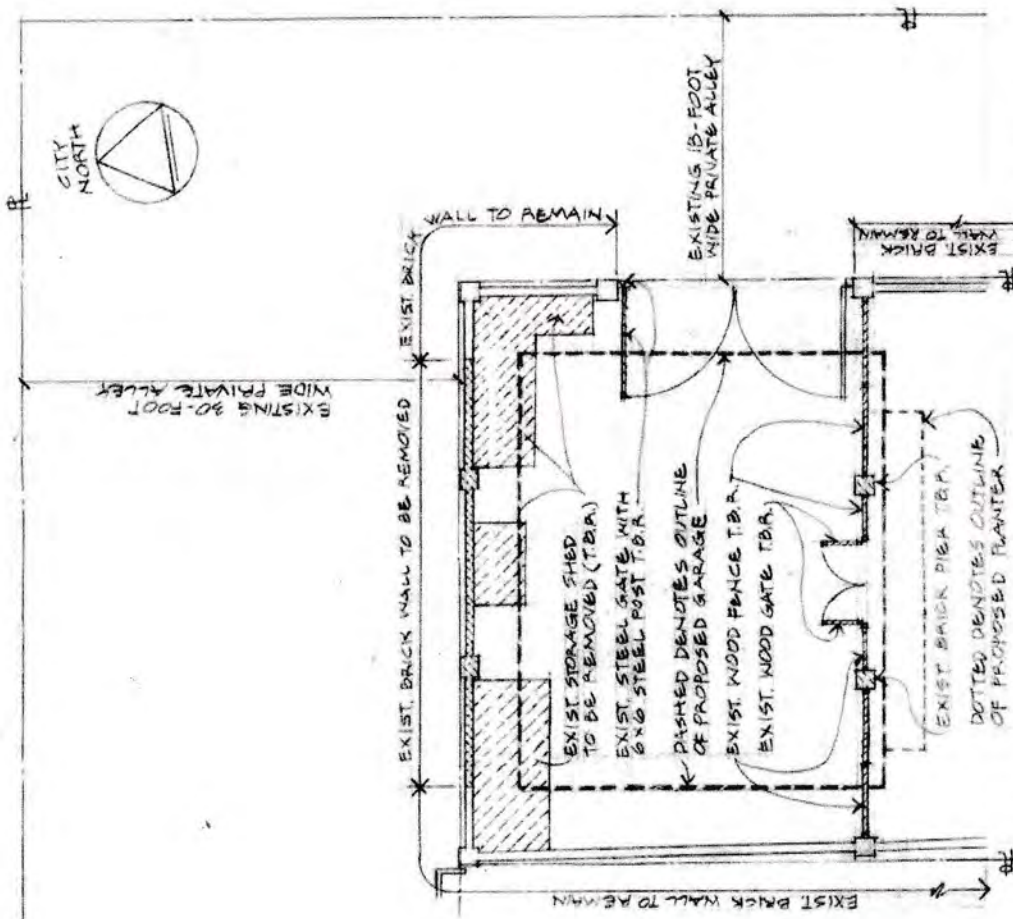
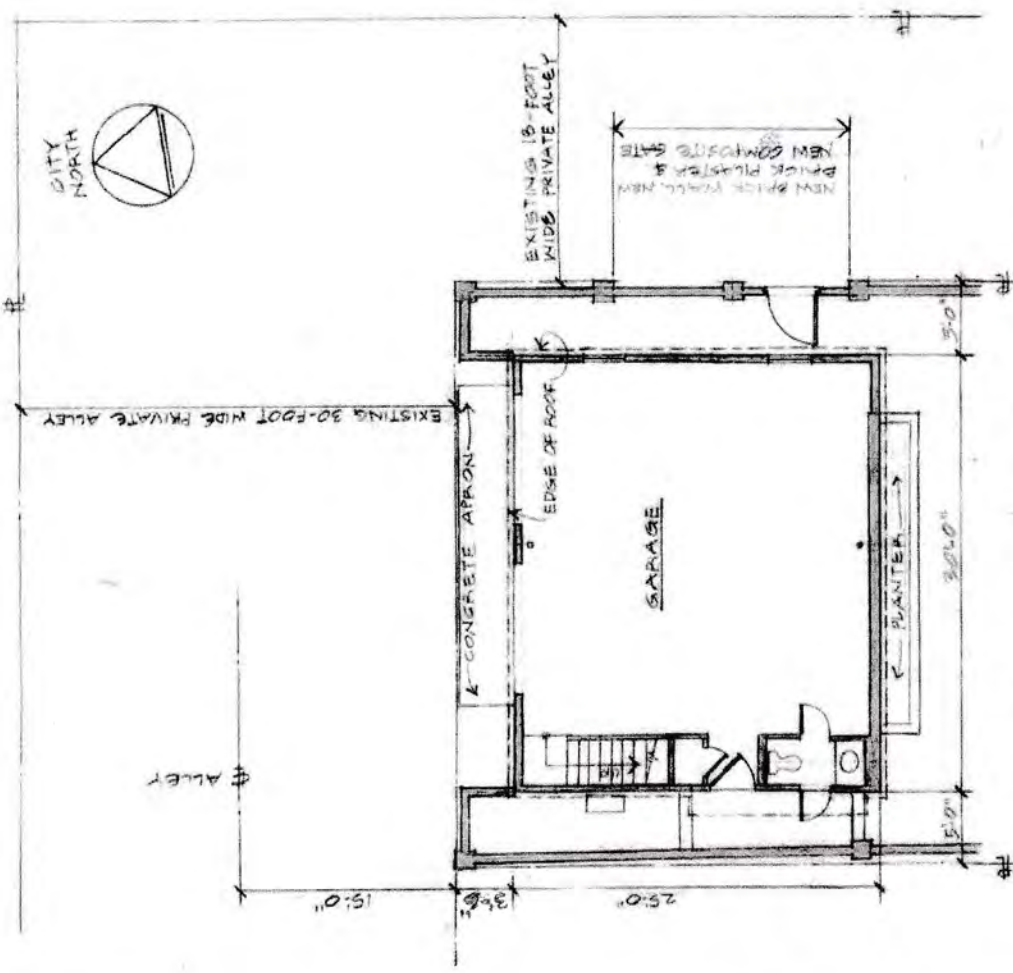

Fig. 2 — Sizes 9K and 12K



EXISTING CONDITIONS/DEMOLITION PLAN
1/8" = 1'-0"



SCHEMATIC GROUND FLOOR PLAN
1/8" = 1'-0"

PROPOSED ADDITION TO 109 DUKE STREET, ALEXANDRIA, VIRGINIA 22314
JOHN SAVAGE, ARCHITECT
8/8/2022

DRAWING
A-1
22 DWG. 1 OF 6



EXTERIOR ELEVATION NOTES
South Elevation

- 1 Fiber cement lap siding, 5" exposure
- 2 PVC corner board
- 3 PVC skirt board with integral flashing
- 4 Wood brace
- 5 Face brick
- 6 Stone cap
- 7 Standing seam metal roofing
- 8 PVC trim
- 9 Half round copper gutter
- 10 Metal railing
- 11 Lowered cupola
- 12 Metal cupola roofing
- 13 Weathervane
- 14 Copper downspout
- 15 Screen door over 15 lite glass door
- 16 PVC fascia
- 17 Wood casement window
- 18 Mini-split outdoor unit
- 19 Lighting fixture
- 20 Metal edge trim
- 21 Wood railing
- 22 Brick steps

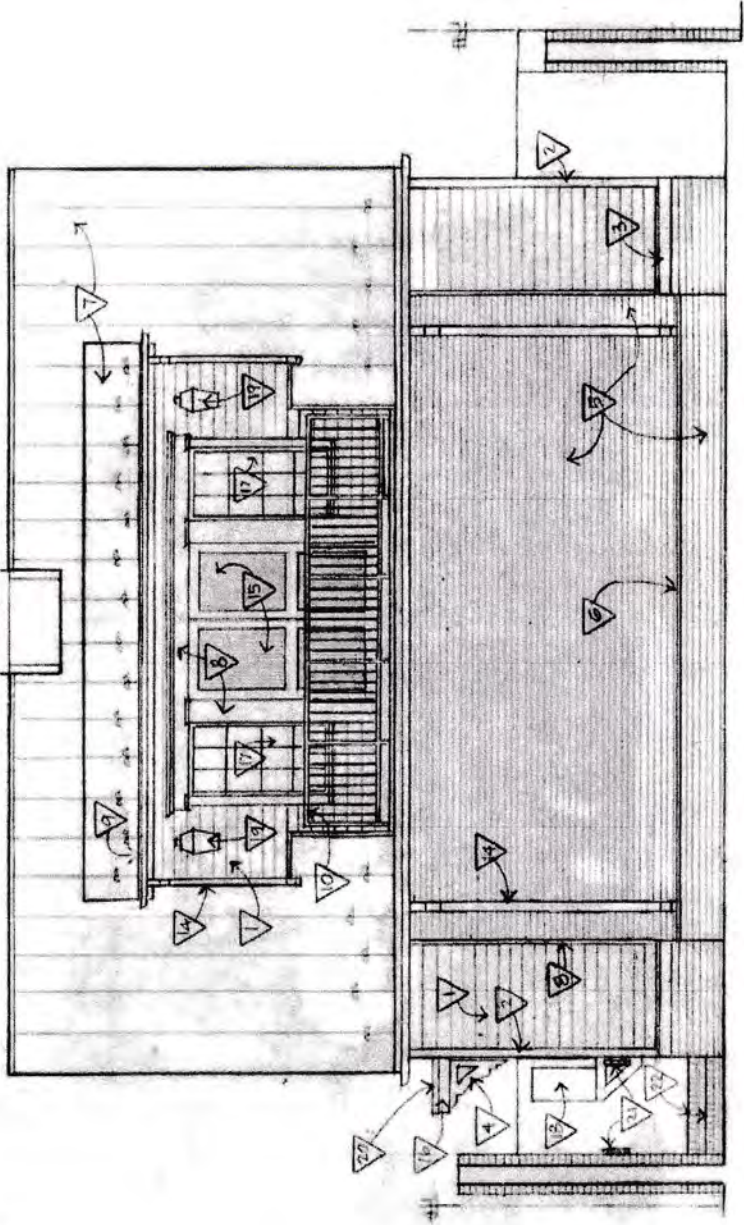

SOUTH ELEVATION
 1/4" = 1'-0"

PROPOSED ADDITION TO 109 DUKE STREET, ALEXANDRIA, VIRGINIA 22314
 JOHN SAVAGE, ARCHITECT
 8/8/2022

DRAWING
 A-2
 PAGE 2 OF 6

23

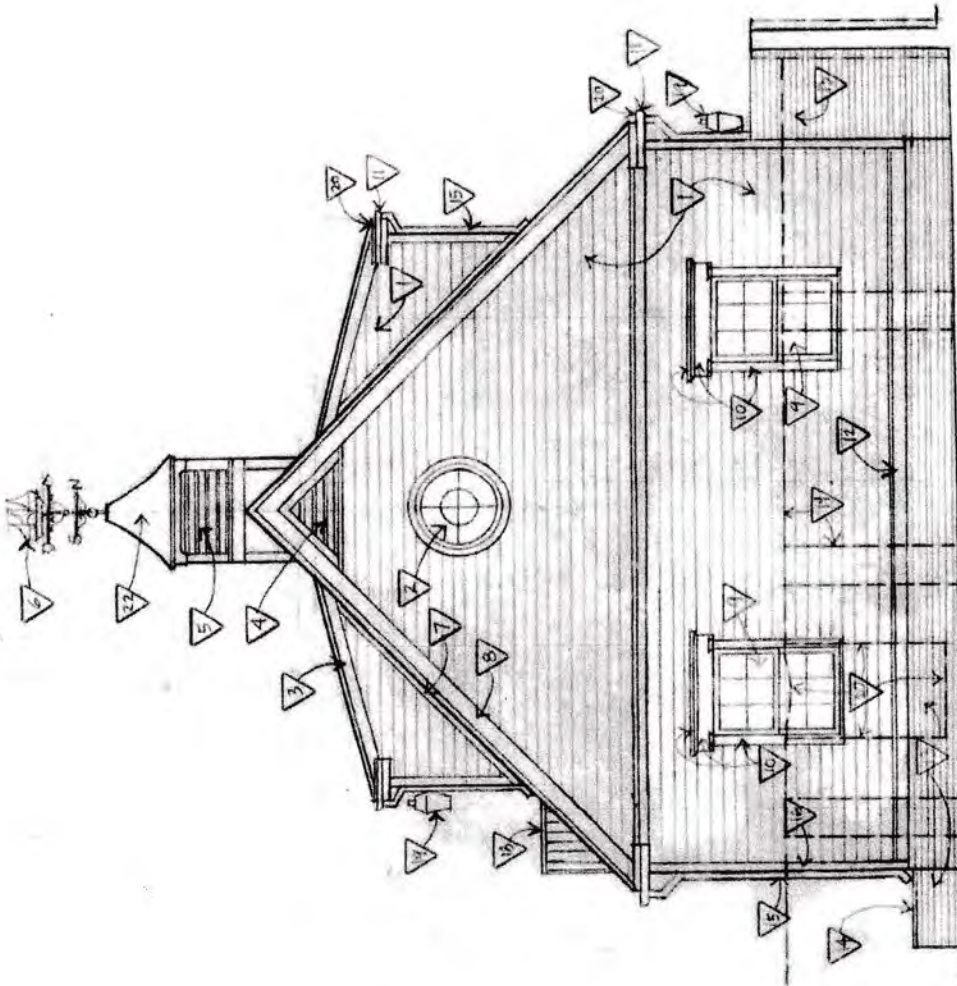

EXTERIOR ELEVATION NOTES
East Elevation

- 1 Fiber cement lap siding, 5" exposure
- 2 Fixed window
- 3 1 x 6 rake board with PVC edge trim
- 4 PVC louver
- 5 Lowered cupola
- 6 Weathervane
- 7 Metal flashing
- 8 1 x 10 PVC rake board with PVC edge trim
- 9 Wood double hung window
- 10 PVC trim
- 11 Half round copper gutter
- 12 PVC band board with integral drip edge
- 13 Face brick
- 14 Stone cap
- 15 Copper downspout
- 16 PVC corner board
- 17 Lighting fixture
- 18 Metal railing
- 19 Outline of brick wall or plaster in foreground
- 20 Outline of new exterior door in foreground

EAST ELEVATION
 1/4" = 1'-0"

PROPOSED ADDITION TO 109 DUKE STREET, ALEXANDRIA, VIRGINIA 22314
8/18/2022

JOHN SAVAGE, ARCHITECT

DRAWING
 A-5
 24
 3 OF 6

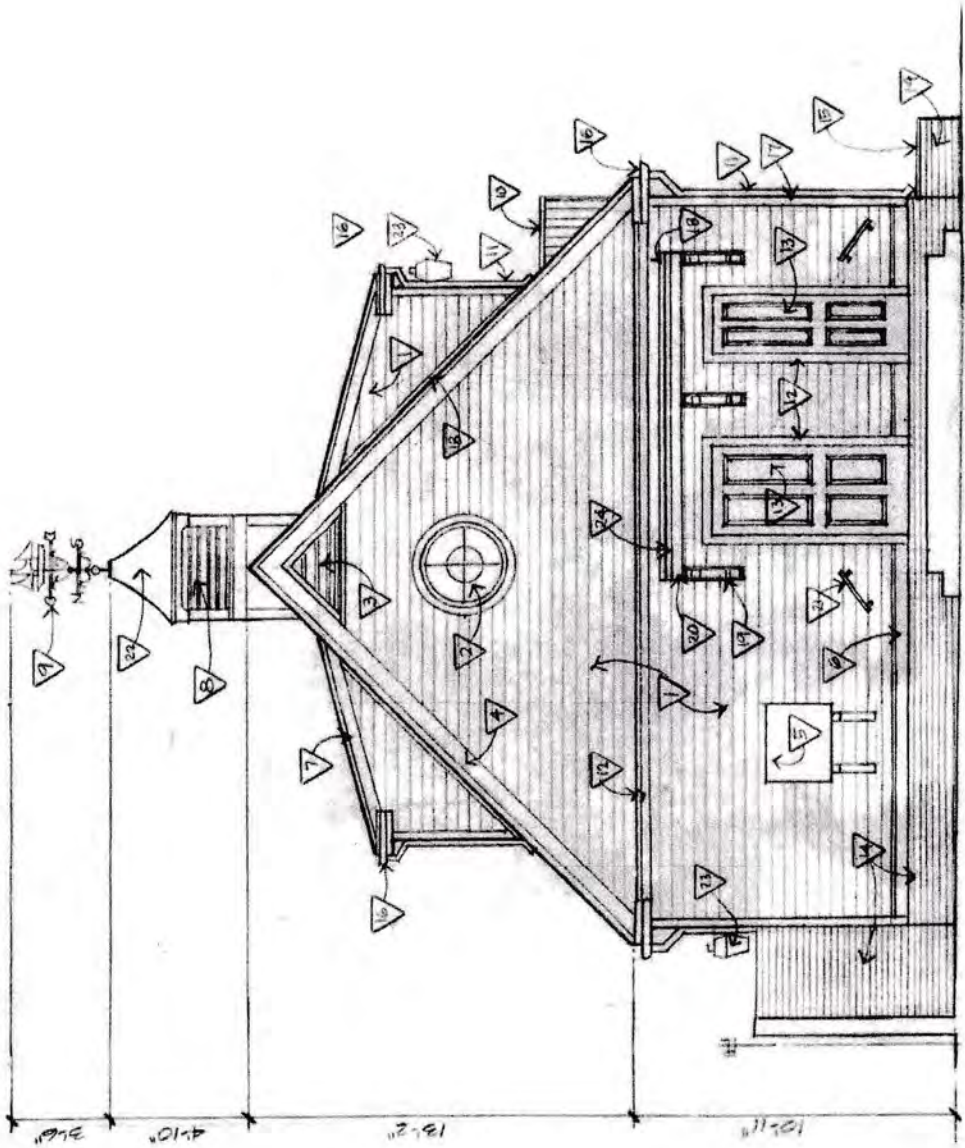

EXTERIOR ELEVATION NOTES
West Elevation

- 1 Fiber cement siding, 5" exposure
- 2 Fixed window
- 3 PVC louver
- 4 1 x 10 PVC rake board with PVC edge trim
- 5 Mini-split outdoor unit
- 6 PVC skirt board with integral drip edge
- 7 1 x 6 PVC rake board with PVC edge trim
- 8 Louvered cupola
- 9 Weathervane
- 10 Metal railing
- 11 Copper downspout
- 12 PVC trim
- 13 Four panel wood door
- 14 Face brick
- 15 Stone cap
- 16 Half round copper gutter
- 17 PVC corner board
- 18 Metal flashing
- 19 Wood brace
- 20 PVC fascia
- 21 Wood railing
- 22 Metal cupola roofing
- 23 Lighting fixture
- 24 Metal edging

WEST ELEVATION
1/4" = 1'-0"

NOTE: THIS ELEVATION IS NOT
VISIBLE FROM THE
PUBLIC WAY

PROPOSED ADDITION TO 109 DUKE STREET, ALEXANDRIA, VIRGINIA 22314
8/8/2022
JOHN SAVAGE ARCHITECT

DRAWINGS
A-4
DN.G 4 OF 6

25

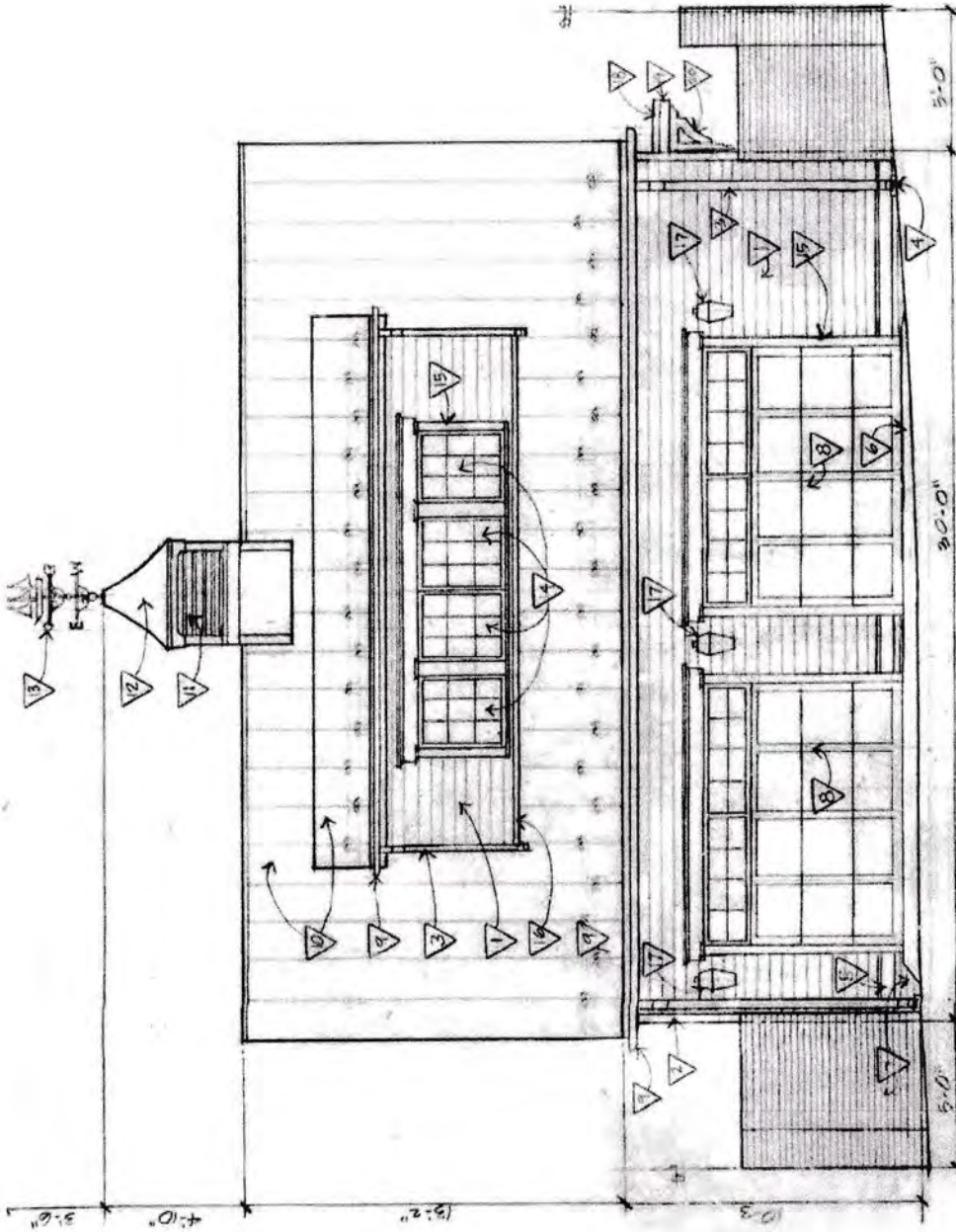

EXTERIOR ELEVATION NOTES
North Elevation

- 1 Fiber cement lap siding, 5" exposure
- 2 PVC corner board
- 3 Copper downspout
- 4 Concrete splash block
- 5 PVC skirt board with integral drip edge
- 6 Concrete apron
- 7 Face brick
- 8 Garage door
- 9 Half round copper gutter
- 10 Standing seam metal roofing
- 11 Louvered cupola
- 12 Metal cupola roofing
- 13 Weathervane
- 14 Wood casement window
- 15 PVC trim
- 16 Metal flashing
- 17 Lighting fixture
- 18 Metal edge trim
- 19 PVC fascia
- 20 Wood brace

NOTE: THIS ELEVATION IS NOT VISIBLE FROM THE PUBLIC WAY
NORTH ELEVATION
1/4" = 1'-0"

DRAWING
A-5
PAGE 5 OF 16

PROPOSED ADDITION TO 109 DUKE STREET, ALEXANDRIA, VIRGINIA 22314
8/15/2022
JOHN SAVAGE, ARCHITECT

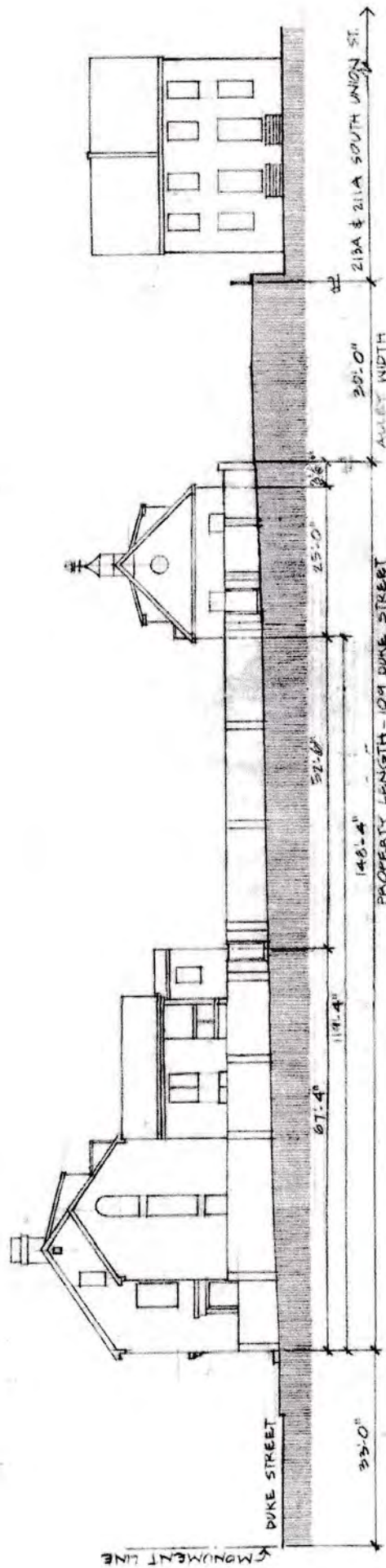

LONGITUDINAL SECTION THRU 18-FOOT WIDE PRIVATE ALLEY

1/8" = 1'-0"

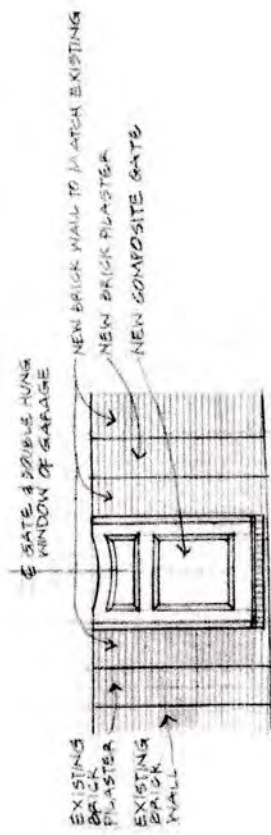

ELEVATION OF NEW GATE

1/4" = 1'-0"

DRAWING
A-6
DNIG 6 OF 6

27

PROPOSED ADDITION TO 109 DUKE STREET, ALEXANDRIA, VIRGINIA 22314
8/2/2022
JOHN SAVAGE, ARCHITECT

NOTES:

1. THE PROPERTY DEMONSTRATED HEREON IS SHOWN AS THE MAP # 0715-02-01 AND IS ZONED R4 (TWO-FAMILY ZONE).
2. OWNER: STEVEN OR MARTHA, PETERSON
ALEXANDRIA, VIRGINIA 22314
INSTRUMENT # 18003759
3. NO TITLE REPORT FURNISHED.
4. THIS PROPERTY IS SUBJECT TO RESTRICTIONS OF RECORD.
5. ELEVATIONS ARE REFERENCED TO NAVD '84.
6. GAS MAIN, WATER MAIN, AND SANITARY LATERAL LOCATIONS (IF DEPICTED) ARE APPROXIMATE AND ARE SHOWN FROM AVAILABLE RECORDS AND/OR FIELD SURVEY. THE SURVEYOR HAS NO LIABILITY TO VERIFY LOCATIONS PRIOR TO ANY LAND DISTURBANCE.
7. UTILITIES ARE UNDERGROUND.
8. THIS PROPERTY IS NOT LOCATED WITHIN A RESIDENCE PROTECTION AREA FOR THE CORRESPONDING ANY PRESERVATION ORDINANCE.
9. FENCES ARE WOODGIRT IRON UNLESS NOTED.
10. WALLS ARE 6" BRICK UNLESS NOTED.
11. PILLARS ARE 1.5" SQUARE BRICK.
12. AREA = 5,933 SQUARE FEET.

TOPOGRAPHIC SURVEY CERTIFICATION:

I, CONRAD H. O'BRIEN, L.L., THE SURVEYOR, CERTIFY THAT THE TOPOGRAPHIC SURVEY WAS COMPLETED UNDER MY DIRECT AND RESPONSIBLE CHARGE FROM AN ACTUAL SURVEY OF THE PROPERTY AND THAT THE SURVEY WAS CONDUCTED ON APRIL 20, 2021 AND REVISED ON JULY 08, 2022, AND THAT THE PLAT, MAP OR DIGITAL GEOSPATIAL DATA INCLUDING METADATA, MEETS MINIMUM ACCURACY STANDARDS, UNLESS OTHERWISE NOTED.

TOPOGRAPHIC SURVEY

ON

LOT 509

PETERSON PROPERTY

CITY OF ALEXANDRIA, VIRGINIA

SCALE: 1" = 10'

JULY 08, 2022 (REVISE PLAT)



DOMINION Surveys
INC.

8808 HILARY TREE VILLAGE COURT
ALEXANDRIA, VIRGINIA 22309
703-619-6555
FAX 703-798-6412

#41299809-6
SHEET 1 OF 1

28

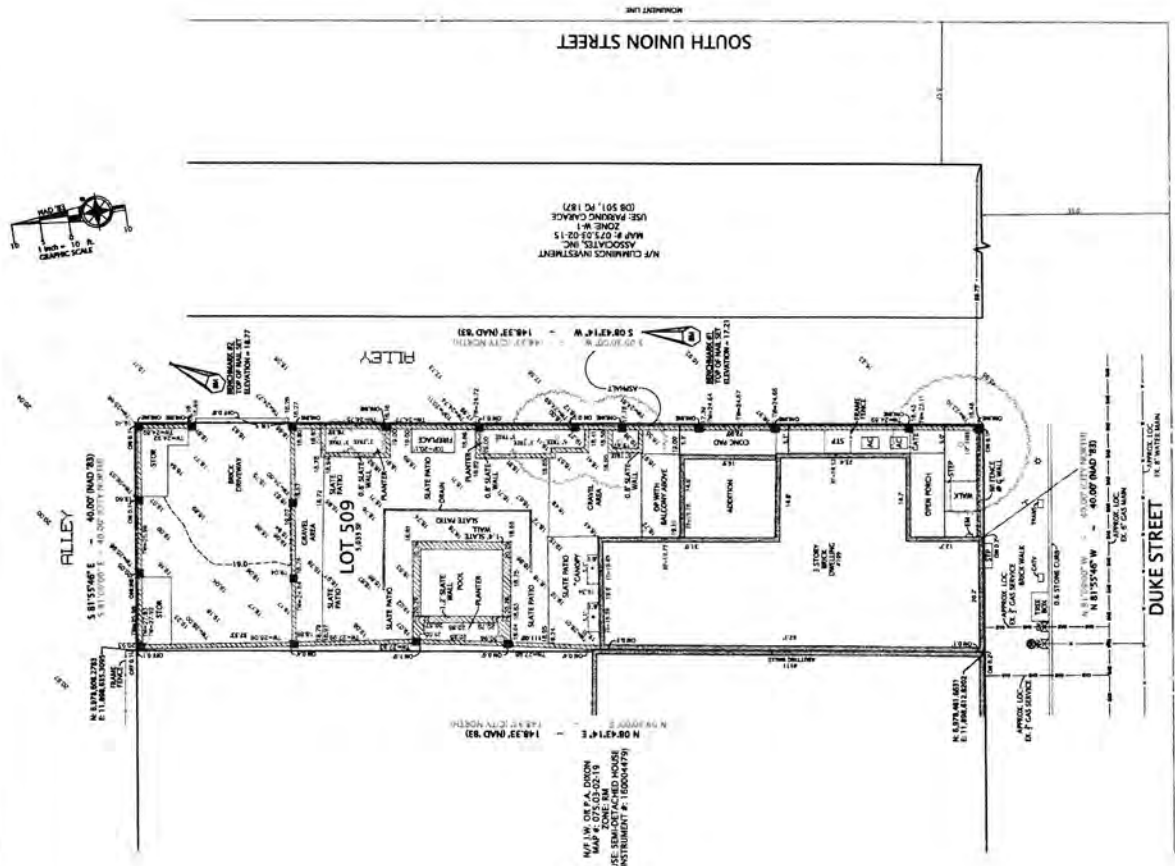

LEGEND	
AC	ACREAGE
BL	BASELINE
BM	BENCHMARK
BR	BROCKMARK
CA	CABLE TV
CONC	CONCRETE
DR	DRIVE
EM	ELECTRIC METER
GA	GAS VALVE
GL	GAS UNDERGROUND
GP	GAS PIPING
GR	GRASS
IR	IRON
STOR	STORAGE
STP	STREET
TRNS	TRANSFORMER
TP	TOP OF WALL
WV	WATER VALVE
W	WATER UNDERGROUND
WV	WATER VALVE
272.8	SPOT ELEVATION
---	NOTED
---	CONTOUR

PARTIAL PLOT
PLAN SHOWING
OUTLINE OF
GARAGE
1" = 10'-0"



ON 19
HOUSE 14479)

N 08°43'14" E
N 09°30'00" E
148.33' (NAD '83)
148.33' (CITY NORTH)

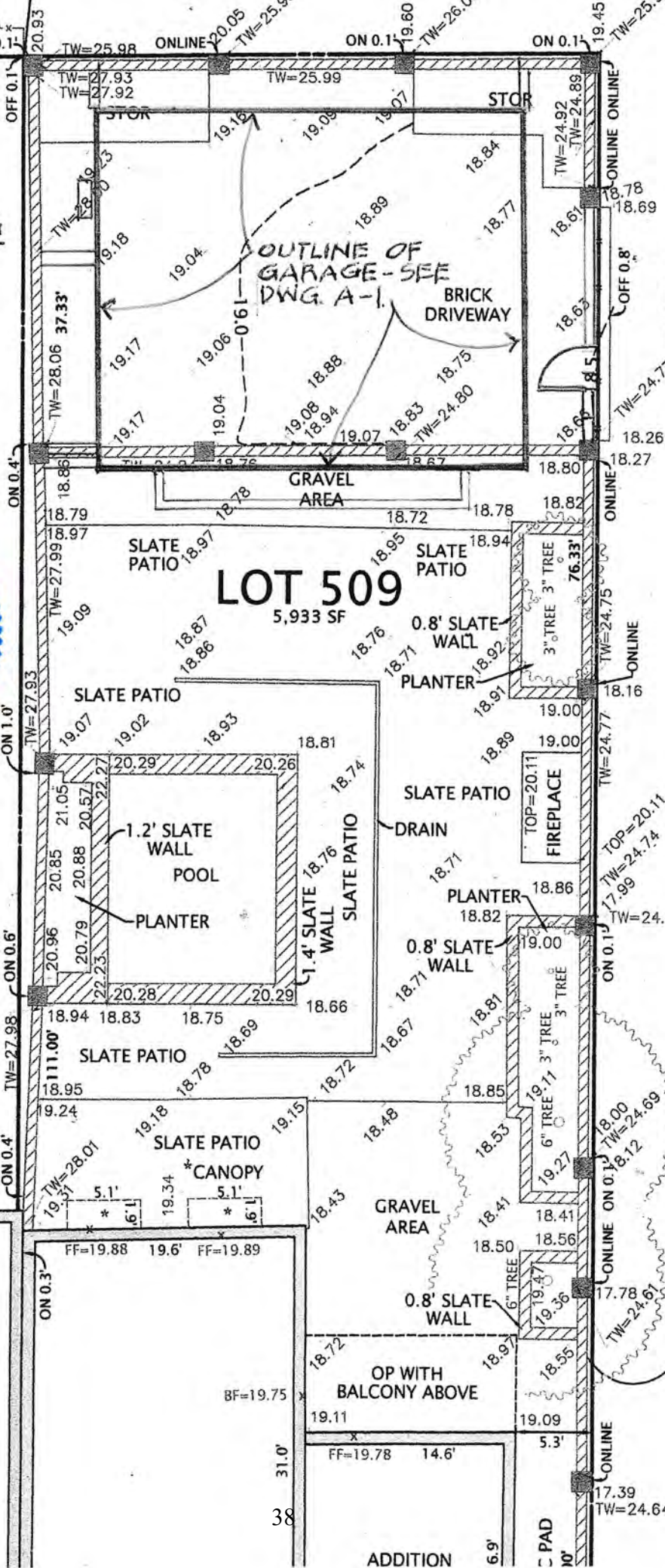

BENCHMARK #2
TOP OF NAIL SET
ELEVATION = 18.77

ALLEY

S 09°30'00" W
S 08°43'14" W
148.33' (CITY NORTH)
148.33' (NAD '83)

BENCHMARK #1
TOP OF NAIL SET
ELEVATION = 17.21